

GIGABYTE™

G894-AD3-AAX7

HPC/AI Server - Intel® Xeon® 6 Processors - 8U DP NVIDIA HGX™ B300

User Manual

Rev. 1.0

Copyright

© 2026 Giga Computing Technology CO., LTD. All rights reserved.

The trademarks mentioned in this manual are legally registered to their respective owners.

Disclaimer

Information in this manual is protected by copyright laws and is the property of Giga Computing. Changes to the specifications and features in this manual may be made by Giga Computing without prior notice. No part of this manual may be reproduced, copied, translated, transmitted, or published in any form or by any means without Giga Computing's prior written permission.

Documentation Classifications

In order to assist in the use of this product, Giga Computing provides the following types of documentation:

- User Manual: detailed information & steps about the installation, configuration and use of this product (e.g. motherboard, server barebones), covering hardware and BIOS.
- User Guide: detailed information about the installation & use of an add-on hardware or software component (e.g. BMC firmware, rail-kit) compatible with this product.
- Quick Installation Guide: a short guide with visual diagrams that you can reference easily for installation purposes of this product (e.g. motherboard, server barebones).

Please see the support section of the online product page to check the current availability of these documents.



For More Information

For related product specifications, the latest firmware and software, and other information please visit our website at <http://www.gigabyte.com/Enterprise>

For any general sales or marketing enquiries, you may also message GIGABYTE server directly by email: marketing@gigacomputing.com

Conventions

The following conventions are used in this user's guide:

	NOTE! Gives bits and pieces of additional information related to the current topic.
	CAUTION! Gives precautionary measures to avoid possible hardware or software problems.
	WARNING! Alerts you to any damage that might result from doing or not doing specific actions.

Server Warnings and Cautions

Before installing a server, be sure that you understand the following warnings and cautions.



WARNING!

To reduce the risk of electric shock or damage to the equipment:

- Do not disable the power cord grounding plug. The grounding plug is an important safety feature.
- Plug the power cord into a grounded (earthed) electrical outlet that is easily accessible at all times.
- Unplug all the power cords from the power supplies to disconnect power to the equipment.

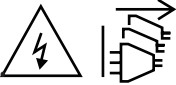

- Shock Hazard! Disconnect all power supply cords before servicing.
- Do not route the power cord where it can be walked on or pinched by items placed against it. Pay particular attention to the plug, electrical outlet, and the point where the cord extends from the server.



WARNING!

To reduce the risk of personal injury from hot surfaces, allow the drives and the internal system components to cool before touching them.



WARNING!

This server is equipped with high speed fans. Keep away from hazardous moving fan blades during servicing.



WARNING!

This equipment is intended to be used in Restrict Access Location. The access can only be gained by Skilled person. Only authorized by well trained professional person can access the restrict access location.



WARNING!

The equipment should only be repaired, maintained or replaced by skilled personnel.



CAUTION!

- Do not operate the server for long periods with the access panel open or removed. Operating the server in this manner results in improper airflow and improper cooling that can lead to thermal damage.
- Danger of explosion if battery is incorrectly replaced.
- Replace only with the same or equivalent type recommended by the manufacturer.
- Dispose of used batteries according to the manufacturer's instructions.



CAUTION!

Risk of explosion if battery is replaced incorrectly or with an incorrect type. Replace the battery only with the same or equivalent type recommended by the manufacturer. Dispose of used batteries according to the manufacturer's instructions.

Electrostatic Discharge (ESD)



CAUTION!

ESD CAN DAMAGE DRIVES, BOARDS, AND OTHER PARTS. WE RECOMMEND THAT YOU PERFORM ALL PROCEDURES AT AN ESD WORKSTATION. IF ONE IS NOT AVAILABLE, PROVIDE SOME ESD PROTECTION BY WEARING AN ANTI-STATIC WRIST STRAP ATTACHED TO CHASSIS GROUND -- ANY UNPAINTED METAL SURFACE -- ON YOUR SERVER WHEN HANDLING PARTS.

Always handle boards carefully. They can be extremely sensitive to ESD. Hold boards only by their edges without any component and pin touching. After removing a board from its protective wrapper or from the system, place the board component side up on a grounded, static free surface. Use a conductive foam pad if available but not the board wrapper. Do not slide board over any surface.

System power on/off: To remove power from system, you must remove the system from rack. Make sure the system is removed from the rack before opening the chassis, adding, or removing any non hot-plug components.

Hazardous conditions, devices and cables: Hazardous electrical conditions may be present on power, telephone, and communication cables. Turn off the system and disconnect the cables attached to the system before servicing it. Otherwise, personal injury or equipment damage can result.

Electrostatic discharge (ESD) and ESD protection: ESD can damage drives, boards, and other parts. We recommend that you perform all procedures in this chapter only at an ESD workstation. If one is not available, provide some ESD protection by wearing an antistatic wrist strap attached to chassis ground (any unpainted metal surface on the server) when handling parts.

ESD and handling boards: Always handle boards carefully. They can be extremely sensitive to electrostatic discharge (ESD). Hold boards only by their edges. After removing a board from its protective wrapper or from the system, place the board component side up on a grounded, static free surface. Use a conductive foam pad if available but not the board wrapper. Do not slide board over any surface.

Installing or removing jumpers: A jumper is a small plastic encased conductor that slips over two jumper pins. Some jumpers have a small tab on top that can be gripped with fingertips or with a pair of fine needle nosed pliers. If the jumpers do not have such a tab, take care when using needle nosed pliers to remove or install a jumper; grip the narrow sides of the jumper with the pliers, never the wide sides. Gripping the wide sides can damage the contacts inside the jumper, causing intermittent problems with the function controlled by that jumper. Take care to grip with, but not squeeze, the pliers or other tool used to remove a jumper, or the pins on the board may bend or break.

Table of Contents

Chapter 1 Hardware Installation	9
1-1 Installation Precautions	9
1-2 Product Specifications	10
1-3 System Block Diagram	12
1-4 PCIe Block Diagram	13
Chapter 2 System Appearance	14
2-1 Front View	14
2-2 Rear View	15
2-3 Top View	16
2-4 Front Panel LED and Buttons	17
2-4-1 RoT LEDs	18
2-5 Front Panel System LAN LEDs	20
2-6 Power Supply Unit (PSU) LED	21
2-7 Hard Disk Drive LEDs	22
Chapter 3 System Hardware Installation	23
3-1 Removing and Installing the Chassis Top Cover	24
3-2 Removing and Installing the GPU Tray	25
3-3 Removing and Installing the Motherboard Tray	26
3-4 Removing the Heat Sink	27
3-5 Installing the CPU	28
3-6 Installing the Memory	30
3-6-1 Eight Channel Memory Configuration	30
3-6-2 Installing the Memory	31
3-6-3 DIMM Population Table	32
3-6-4 Processor and Memory Module Matrix Table	33
3-7 Installing the PCI Expansion Card	34
3-8 Installing the Hard Disk Drive	36
3-9 Installing the M.2 Device and Heat Sink	37
3-10 Replacing the System Fan Module	38
3-11 Removing and Installing the Power Supply	40
3-12 Installing the System into the Cabinet	41
3-13 Removing the System from the Cabinet	42
3-14 Cable Connection	44

- Chapter 4 Motherboard Components48
 - 4-1 Motherboard Components 48
 - 4-2 Jumper Setting 50
 - 4-3 Backplane Board Storage Connector 51
 - 4-3-1 CBPG64151
- Chapter 5 BIOS Setup 52
 - 5-1 The Main Menu 54
 - 5-2 Advanced Menu 57
 - 5-2-1 Trusted Computing58
 - 5-2-2 Serial Port Console Redirection59
 - 5-2-3 SIO Configuration62
 - 5-2-4 PCI Subsystem Settings63
 - 5-2-5 USB Configuration65
 - 5-2-6 Network Stack Configuration66
 - 5-2-7 Post Report Configuration67
 - 5-2-8 KMS Policy Configuration68
 - 5-2-9 NVMe Configuration70
 - 5-2-10 Chipset Configuration71
 - 5-2-11 Tls Auth Configuration72
 - 5-2-12 iSCSI Configuration73
 - 5-2-13 Intel(R) Ethernet Controller X710 for 10GBASE-T74
 - 5-2-14 VLAN Configuration77
 - 5-2-15 MAC IPv6 Network Configuration78
 - 5-2-16 MAC IPv4 Network Configuration79
 - 5-2-17 Driver Health80
 - 5-3 Chipset Menu 81
 - 5-3-1 Processor Configuration82
 - 5-3-2 Common RefCode Configuration85
 - 5-3-3 UPI Configuration86
 - 5-3-4 Memory Configuration88
 - 5-3-5 IIO Configuration91
 - 5-3-6 Advanced Power Management Configuration93
 - 5-3-7 Miscellaneous Configuration96
 - 5-3-8 Runtime Error Logging97
 - 5-3-9 Power Policy99
 - 5-4 Server Management Menu 101
 - 5-4-1 System Event Log103
 - 5-4-2 View FRU Information104
 - 5-4-3 BMC VLAN Configuration105

5-4-4	BMC Network Configuration	106
5-4-5	IPv6 BMC Network Configuration	107
5-5	Security Menu	108
5-5-1	Secure Boot	109
5-6	Boot Menu	112
5-7	Save & Exit Menu.....	114
5-8	BIOS Recovery	116

Chapter 1 Hardware Installation

1-1 Installation Precautions

The motherboard/system contain numerous delicate electronic circuits and components which can become damaged as a result of electrostatic discharge (ESD). Prior to installation, carefully read the user manual and follow these procedures:







- Prior to installation, do not remove or break motherboard S/N (Serial Number) sticker or warranty sticker provided by your dealer. These stickers are required for warranty validation.
- Always remove the AC power by unplugging the power cord from the power outlet before installing or removing the motherboard or other hardware components.
- When connecting hardware components to the internal connectors on the motherboard, make sure they are connected tightly and securely.
- When handling the motherboard, avoid touching any metal leads or connectors.
- It is best to wear an electrostatic discharge (ESD) wrist strap when handling electronic components such as a motherboard, CPU or memory. If you do not have an ESD wrist strap, keep your hands dry and first touch a metal object to eliminate static electricity.
- Prior to installing the motherboard, please have it on top of an antistatic pad or within an electrostatic shielding container.
- Before unplugging the power supply cable from the motherboard, make sure the power supply has been turned off.
- Before turning on the power, make sure the power supply voltage has been set according to the local voltage standard.
- Before using the product, please verify that all cables and power connectors of your hardware components are connected.
- To prevent damage to the motherboard, do not allow screws to come in contact with the motherboard circuit or its components.
- Make sure there are no leftover screws or metal components placed on the motherboard or within the computer casing.
- Do not place the computer system on an uneven surface.
- Do not place the computer system in a high-temperature environment.
- Turning on the computer power during the installation process can lead to damage to system components as well as physical harm to the user.
- If you are uncertain about any installation steps or have a problem related to the use of the product, please consult a certified computer technician.









1-2 Product Specifications



NOTE:

We reserve the right to make any changes to the product specifications and product-related information without prior notice.

 System Dimension	<ul style="list-style-type: none">◆ 8U◆ 447 x 351 x 923 (W x H x D, mm)
 CPU	<ul style="list-style-type: none">◆ Intel® Xeon® 6 Processors<ul style="list-style-type: none">- Intel® Xeon® 6900-Series Processors◆ Dual processor, TDP up to 500W <p>[Note] If only 1 CPU is installed, some PCIe or memory functions might be unavailable.</p>
 Socket	<ul style="list-style-type: none">◆ 2 x LGA 7529◆ Socket BR
 Chipset	<ul style="list-style-type: none">◆ System on Chip
 Memory	<ul style="list-style-type: none">◆ 24 x DIMM slots◆ Support DDR5 RDIMM/MRDIMM [1]◆ 12-Channel memory per processor◆ RDIMM: Up to 6400 MT/s◆ MRDIMM: Up to 8800 MT/s <p>[1] MRDIMMs are supported only on select Intel® Xeon® 6 processors with P-cores.</p>
 LAN	<p>Front (I/O board):</p> <ul style="list-style-type: none">◆ 2 x 10Gb/s LAN (1 x Intel® X710-AT2)<ul style="list-style-type: none">- Support NCSI function◆ 1 x 10/100/1000 Mbps Management LAN <p>Rear:</p> <ul style="list-style-type: none">◆ 8 x 800 Gb/s OSFP InfiniBand XDR / Dual 400 Gb/s Ethernet, for GPU networking, via NVIDIA ConnectX®-8 SuperNIC™ <p>Rear (MLAN board):</p> <ul style="list-style-type: none">◆ 1 x 10/100/1000 Mbps Management LAN <p>[Note] When both MLAN ports are connected with cables, the front MLAN port will be set as the default.</p>
 Video	<ul style="list-style-type: none">◆ Integrated in Aspeed® AST2600<ul style="list-style-type: none">- 1 x VGA port

	Storage	<p>Front hot-swap:</p> <ul style="list-style-type: none"> ◆ 8 x 2.5" Gen5 NVMe - (NVMe from PEX89072) <p>Internal M.2:</p> <ul style="list-style-type: none"> ◆ 1 x M.2 (2280/22110), PCIe Gen5 x4, from CPU_1 ◆ 1 x M.2 (2280/22110), PCIe Gen5 x2, from CPU_1
	Modular GPU	<ul style="list-style-type: none"> ◆ NVIDIA HGX™ B300 with 8 x SXM GPUs
	Expansion Slot	<ul style="list-style-type: none"> ◆ PCIe Bridge Board x 2: - 4 x FHHL x16 (Gen5 x16), from PEX89072
	Front I/O	<p>I/O board:</p> <ul style="list-style-type: none"> ◆ 2 x USB 3.2 Gen1 ports (Type-A) ◆ 1 x VGA port ◆ 2 x RJ45 ports ◆ 1 x MLAN port (default) ◆ 1 x Power button with LED ◆ 1 x ID button with LED ◆ 1 x NMI button ◆ 1 x Reset button ◆ 1 x Storage activity LED ◆ 1 x System status LED
	Rear I/O	<ul style="list-style-type: none"> ◆ 8 x OSFP ports <p>MLAN board:</p> <ul style="list-style-type: none"> ◆ 1 x MLAN port
	Security Modules	<ul style="list-style-type: none"> ◆ 1 x TPM header with SPI interface - Optional TPM2.0 kit: CTM012
	Power Supply	<ul style="list-style-type: none"> ◆ 12 x 3000W 80 PLUS Titanium redundant power supplies ^[1] <p>[1] The system power supply requires C19 power cord.</p> <p>[Note] GIGABYTE offers PSUs with various efficiency ratings and power outputs. Full redundancy may depend on your server configuration, and alternative PSU options may be needed. Please contact our sales representatives for the best power solution.</p> <p>[Note] Please refer to GIGABYTE Website for detail power supply specification.</p>
	Operating Properties	<ul style="list-style-type: none"> ◆ Operating temperature: 10°C to 30°C ◆ Operating humidity: 8% to 80% (non-condensing) ◆ Non-operating temperature: -40°C to 60°C ◆ Non-operating humidity: 20% to 95% (non-condensing)

1-3 System Block Diagram

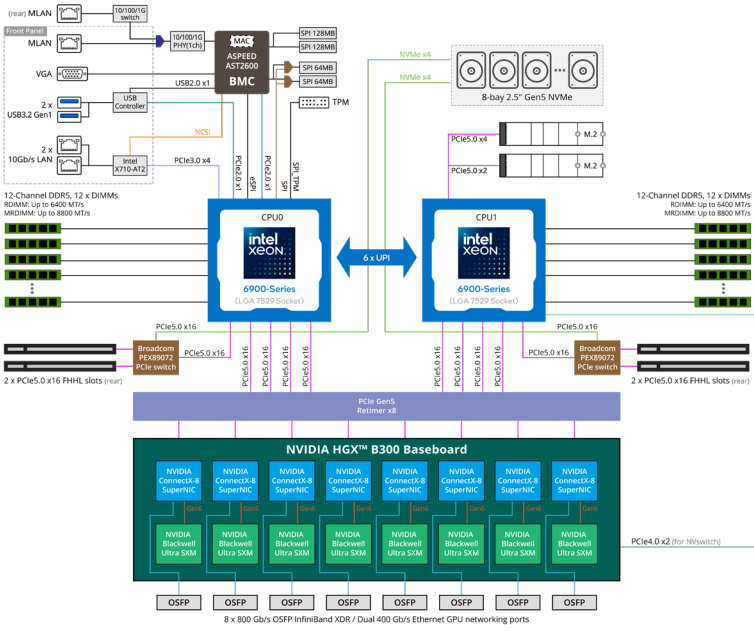

1-4 PCIe Block Diagram

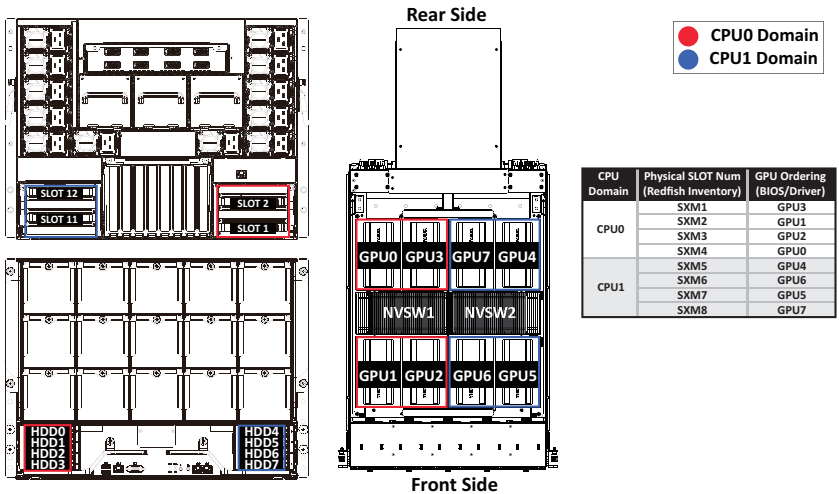

CPU Domain	Physical SLOT Num (Redfish Inventory)	GPU Ordering (BIOS/Driver)
CPU0	SXM1	GPU3
	SXM2	GPU1
	SXM3	GPU2
	SXM4	GPU0
CPU1	SXM5	GPU4
	SXM6	GPU6
	SXM7	GPU5
	SXM8	GPU7

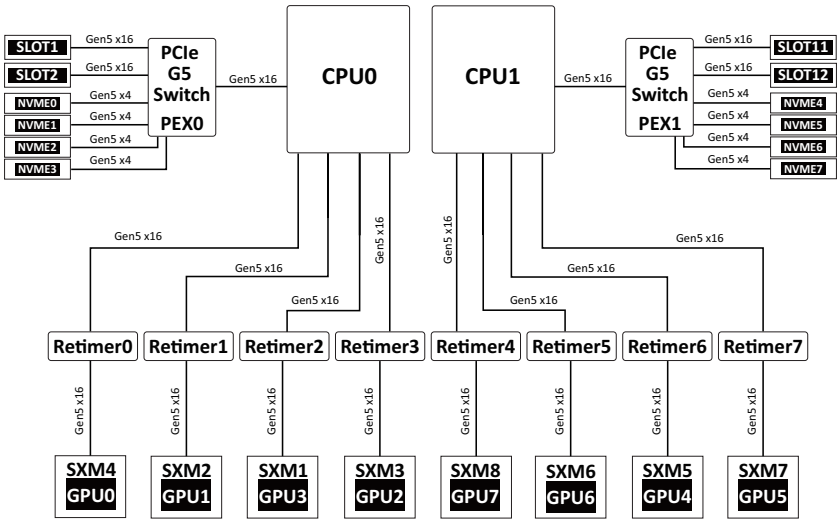

Chapter 2 System Appearance

2-1 Front View

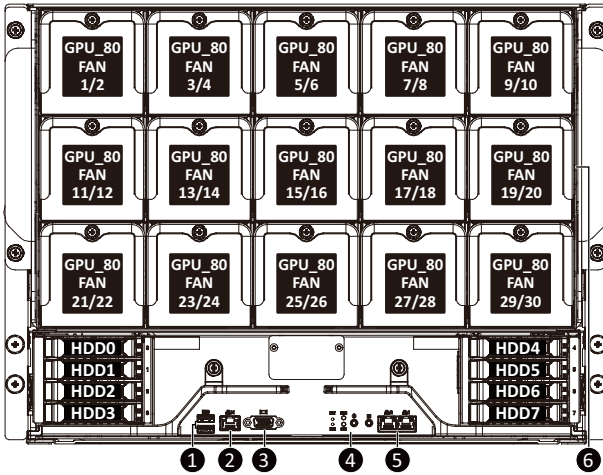

No.	Description
1.	USB 3.2 Gen1 Port x 2
2.	Management LAN Port
3.	VGA Port
4.	Front Panel LEDs and Buttons
5.	Data LAN Port x 2
6.	GPU Tray



- Go to the section **2-4 Front Panel Buttons and LEDs** for detail description of function LEDs.

2-2 Rear View

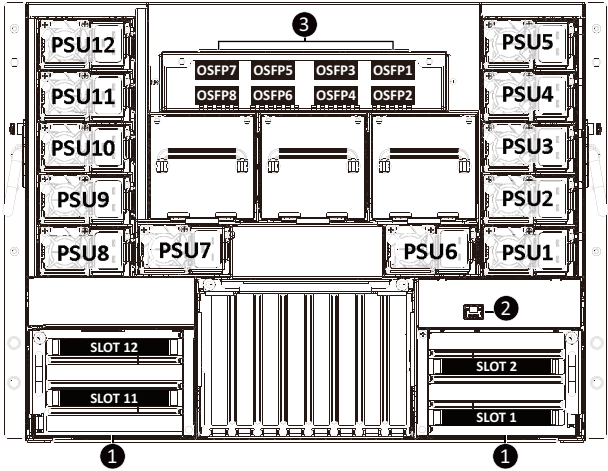

No.	Description
1.	PCIe Card Cage x 2
2.	Management LAN Port
3.	OSFP Port x 8

NOTE!

- Only one Management LAN (Front/Rear side) can be used at a time.

2-3 Top View

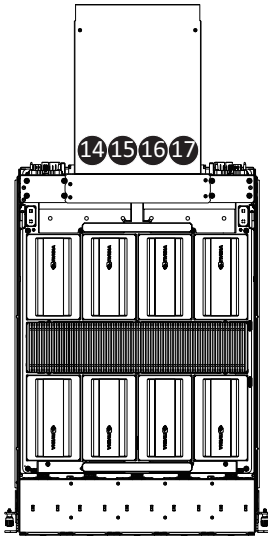
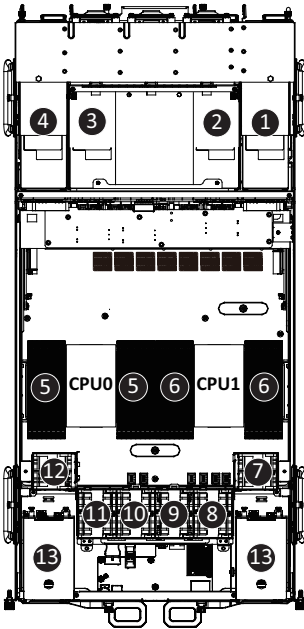

No.	Description
	Power Supply Unit x 5 (Top)
1.	PCIe Slot x 2 (Bottom)
	Rear_BP_80_FAN_7/8 (Bottom)
2.	Power Supply Unit x 1
3.	Power Supply Unit x 1
	Power Supply Unit x 5 (Top)
4.	PCIe Slot x 2 (Bottom)
	Rear_BP_80_FAN_1/2 (Bottom)
5.	CPU0 DDR5 Memory
6.	CPU1 DDR5 Memory
7.	SYS_60_FAN_11/12
8.	SYS_60_FAN_9/10
9.	SYS_60_FAN_7/8
10.	SYS_60_FAN_5/6
11.	SYS_60_FAN_3/4
12.	SYS_60_FAN_1/2
13.	2.5" Storage Bays
14.	SYS_40_FAN_1/2
15.	SYS_40_FAN_3/4
16.	SYS_40_FAN_5/6
17.	SYS_40_FAN_7/8

2-4 Front Panel LED and Buttons

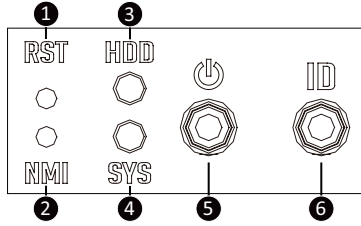

No.	Name	Color	Status	Description
1.	Reset Button			Press the button to reset the system.
2.	NMI button			Press the button server generates a NMI to the processor if the multiple-bit ECC errors occur, which effectively halt the server.
3.	HDD Status LED	Green	On	HDD locate
			Blink	HDD access
		Amber/Amber	On	HDD fault
			Blink	HDD rebuilding
			N/A	Off
4.	System Status LED ^(Note)	Green	On	System is operating normally.
			Amber	On
		Blink		Non-critical condition, may indicate: Redundant power module failure Temperature and voltage issue Chassis intrusion
		N/A	Off	System is not ready, may indicate: POST error NMI error Processor or terminator missing
5.	Power button with LED	Green	On	System is powered on
		N/A	Off	System is not powered on or in ACPI S5 state (power off)
6.	ID Button ^(Note)			Press the button to activate system identification

(Note) If your server features RoT function, please see the following section for detail LED behavior.

2-4-1 RoT LEDs

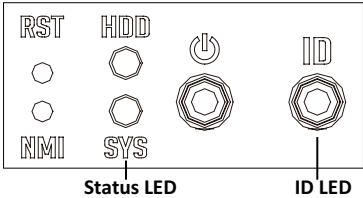

State	LED on Front Panel		LED on PRoT Module
	ID LED	Status LED	Live LED
AST1060 FW Active Authentication fail			
AST1060 : Recovering active region	4Hz	Green and Amber Blink alternately at 4Hz [Green, Amber, Green, Amber, and so on]	4Hz
AST1060 FW Active and Recovery Authentication fail			
Endless attempts to boot from active or recovery.	On	Off	Off
Authenticating BMC/BIOS Images			
Authenticating Images	Off	Off	2Hz
BMC/BIOS Images Authentication Pass			
BMC : Authentication pass BIOS : Authentication pass	Off	Off	0.5Hz
State	LED on Front Panel		LED on PRoT Module

	ID LED	Status LED	Live LED
Recovering BMC/BIOS Images			
BMC : Recovering active region	4Hz	Green Blink at 4Hz	4Hz
BIOS : Recovering active region	4Hz	Amber Blink at 4Hz	4Hz
BMC : Recovering recovery region (If the staging region exists)	4Hz	Green On	4Hz
BIOS : Recovering recovery region (If the staging region exists)	4Hz	Amber On	4Hz
BMC/BIOS Images Active and Recovery region Authentication Fail			
BMC : Active and Recovery authentication fail	On	Green On	2Hz
BIOS : Active and Recovery authentication fail	On	Amber On	2Hz

NOTE!

1. When the BMC/BIOS starts, the LEDs will be controlled by the BMC/BIOS.

2-5 Front Panel System LAN LEDs

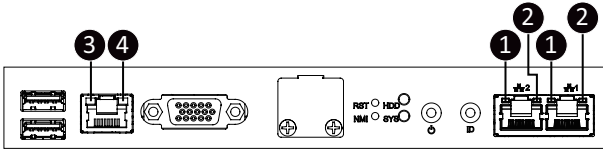

No.	Name	Color	Status	Description
1.	10GbE Speed LED	Green	On	10 Gbps data rate
		Yellow	On	5Gbps, 2.5Gbps, 1Gbps data rate
		N/A	Off	100 Mbps data rate
2.	10GbE Link / Activity LED	Green	On	Link between system and network or no access
			Blink	Data transmission or reception is occurring.
		N/A	Off	No data transmission or reception is occurring.
3.	1GbE Speed LED	Yellow	On	1 Gbps data rate
		Green	On	100 Mbps data rate
		N/A	Off	10 Mbps data rate
4.	1GbE Link / Activity LED	Green	On	Link between system and network or no access
			Blink	Data transmission or reception is occurring.
		N/A	Off	No data transmission or reception is occurring.

2-6 Power Supply Unit (PSU) LED



NOTE!

The power supply may vary based on the system configuration.

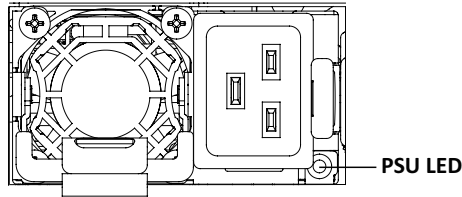

State	Description
OFF	No AC power to all power supplies
1Hz Green Blinking	AC present / only standby on / Cold redundant mode
2Hz Green Blinking	Power supply firmware updating mode
Amber	AC cord unplugged or AC power lost; with a second power supply in parallel still with AC input power
	Power supply critical event causing shut down: failure, OCP, OVP, fan failure and UVP
1Hz Amber Blinking	Power supply warning events where the power supply continues to operate: high temp, high power, high current and slow fan

2-7 Hard Disk Drive LEDs



RAID SKU		LED1	Locate	HDD Fault	Rebuilding	HDD Access	HDD Present (No Access)
No RAID configuration (via ICH, HBA)	Disk LED (LED on Back Panel)	Green	ON(*1)	OFF		BLINK (*2)	OFF
		Amber	OFF	OFF		OFF	OFF
	Removed HDD Slot (LED on Back Panel)	Green	ON(*1)	OFF		--	--
		Amber	OFF	OFF		--	--
RAID configuration (via HW RAID Card or SW RAID Card)	Disk LED	Green	ON	OFF		BLINK (*2)	OFF
		Amber	OFF	ON	(Low Speed: 2 Hz)	OFF	OFF
	Removed HDD Slot	Green	ON(*1)	OFF	(*3)	--	--
		Amber	OFF	ON	(*3)	--	--

LED 2	HDD Present	No HDD
Green	ON	OFF

NOTE:

*1: Depends on HBA/Utility Spec.

*2: Blink cycle depends on HDD's activity signal.

*3: If HDD is pulled out during rebuilding, the disk status of this HDD is regarded as faulty.

Chapter 3 System Hardware Installation



Pre-installation Instructions

Computer components and electronic circuit boards can be damaged by electrostatic discharge. Working on computers that are still connected to a power supply can be extremely dangerous. Follow the simple guidelines below to avoid damage to your computer or injury to yourself.

- Always disconnect the computer from the power outlet whenever you are working inside the computer case.
- If possible, wear a grounded wrist strap when you are working inside the computer case. Alternatively, discharge any static electricity by touching the bare metal system of the computer case, or the bare metal body of any other grounded appliance.
- Hold electronic circuit boards by the edges only. Do not touch the components on the board unless it is necessary to do so. Do not flex or stress the circuit board.
- Leave all components inside the static-proof packaging until you are ready to use the component for the installation.

3-1 Removing and Installing the Chassis Top Cover



Before you remove or install the chassis top cover

- Make sure the system is not turned on or connected to AC power.

Follow these instructions to remove/install the chassis top cover:

1. Remove the screw securing the chassis cover.
2. Push button to unlock the handle.
3. Pull the grip handle to open the panel cover.
4. Slide the cover towards the front of the system and then remove the cover in the direction indicated by the arrow.
5. Follow steps 1-4 in reverse order to re-install the chassis cover

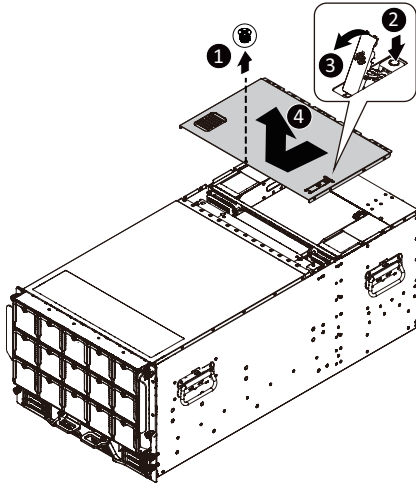

3-2 Removing and Installing the GPU Tray



Before you remove or install the GPU tray:

- Make sure the system is not turned on or connected to AC power.

Follow these instructions to remove/install the GPU tray:

1. Loosen the thumbnail screw securing the handles on both sides of the system.
2. Pull the grip handles on both sides of the system slide the tray to the front of the system at the same time to pull out the tray.
3. Slide the white latch on both sides of the tray rail and carefully remove the GPU tray.
4. To reinstall the GPU tray, align it with the rails on both sides and push the blue latches on each side of the tray rail backward to slide it into the system. Then, reverse steps 1-2 to secure the GPU tray in position.

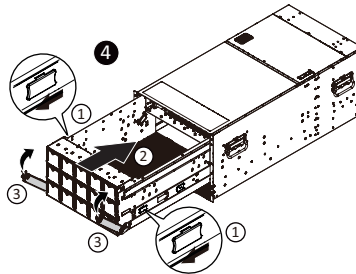
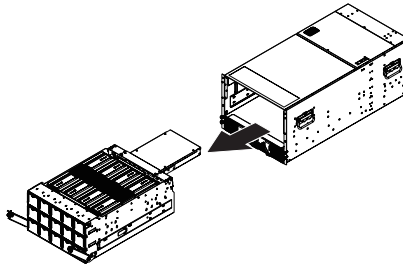
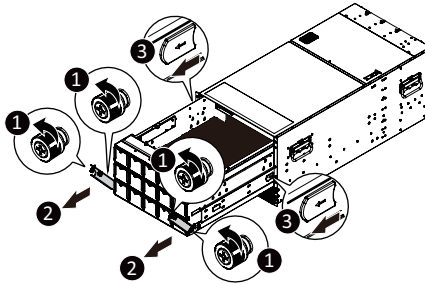

3-3 Removing and Installing the Motherboard Tray



Before you remove or install the Motherboard tray:

- Make sure the system is not turned on or connected to AC power.

Follow these instructions to remove/install the Motherboard tray:

1. Loosen the thumbnail screw securing the handles on both sides of the system.
2. Pull the grip handles on both sides of the system slide the tray to the front of the system at the same time to pull out the tray.
3. Slide the white latch on both sides of the tray rail and carefully remove the Motherboard tray.
4. To reinstall the Motherboard tray, align it with the rails on both sides and push the blue latches on each side of the tray rail backward to slide it into the system. Then, reverse steps 1-2 to secure the Motherboard tray in position.

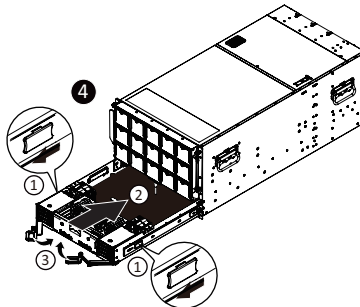
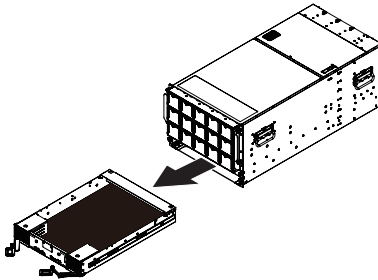
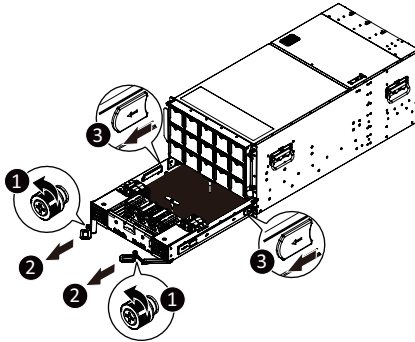

3-4 Removing the Heat Sink



Read the following guidelines before you begin to remove/install the heat sink:

- Always turn off the computer and unplug the power cord from the power outlet before installing the heat sink to prevent hardware damage.
- Unplug all cables from the power outlets.
- Disconnect all telecommunication cables from their ports.
- Place the system unit on a flat and stable surface.
- Open the system according to the instructions.



WARNING!

Failure to turn off the server before you start installing components may cause serious damage. Do not attempt the procedures described in the following sections unless you are a qualified service technician.

Follow these instructions to remove/install the heat sink:

1. Loosen the captive screws securing the heat sink in place in reverse order (4→3→2→1). Move the rotating wires into the unlatch position.
2. Lift and remove the heat sink from the system.
3. To reinstall the heat sink reverse steps 1-2 while ensuring that you tighten the captive screws in sequential order (1→2→3→4).

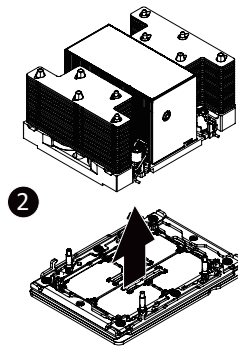
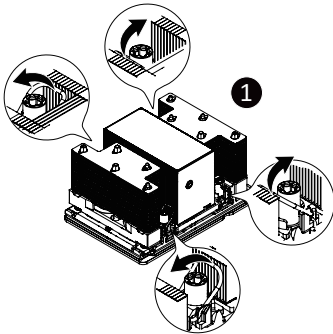

- When installing the heat sink to CPU, use T30-Lobe driver to tighten 4 captive nuts in sequence as 1-4. Please refer to the Heat Sink Label for the screw tightening torque value.
- To ensure the system operates properly, make sure the heat sink is seated on the processor firmly.

3-5 Installing the CPU



Read the following guidelines before you begin to install the CPU:

- Make sure that the motherboard supports the CPU.
- Always turn off the computer and unplug the power cord from the power outlet before installing the CPU to prevent hardware damage.
- Unplug all cables from the power outlets.
- Disconnect all telecommunication cables from their ports.
- Place the system unit on a flat and stable surface.
- Open the system according to the instructions.



WARNING!

Failure to properly turn off the server before you start installing components may cause serious damage. Do not attempt the procedures described in the following sections unless you are a qualified service technician.

Follow these instructions to Install the CPU:

1. Align and install the processor on the carrier.

NOTE: Apply thermal compound evenly on the top of the CPU. Remove the protective cover from the underside of the heat sink.

2. Carefully flip the heat sink cover. Then install the carrier assembly on the bottom of the heat sink and make sure the gold arrow is located in the correct direction.

3. Remove the CPU cover.

NOTE: Save the CPU cover in the event that you need to remove the CPU from the socket.

4. Align the heat sink with the CPU socket by the guide pins and make sure the gold arrow is located in the correct direction. Then place the heat sink onto the top of the CPU socket.

5. Position the rotating wires into the latch position. Tighten the screws in sequential order (1→2→3→4).

NOTE: When disassembling the heat sink, loosen the screws in reverse order (4→3→2→1) and then move the rotating wires into the unlatch position.

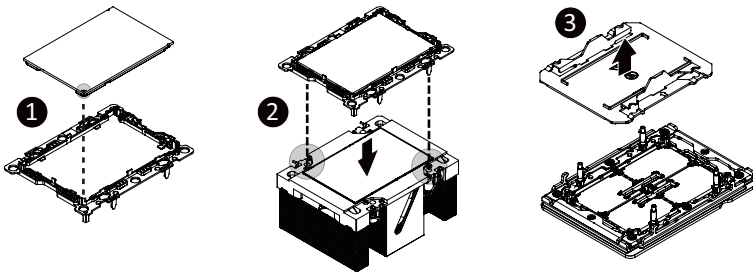

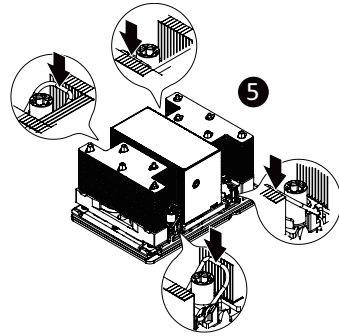
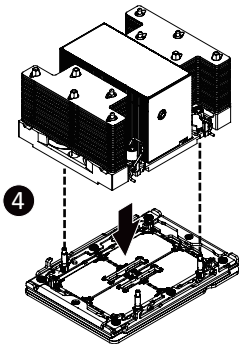

NOTE!

- When installing the Heat Sink to CPU, use T30-Lobe driver to tighten 4 captive nuts in sequence as 1-4.
- Please refer to the Heat Sink Label for the screw tightening torque value.

3-6 Installing the Memory



Read the following guidelines before you begin to install the memory:

- Make sure that the motherboard supports the memory. It is recommended that memory of the same capacity, brand, speed, and chips be used.
- Always turn off the computer and unplug the power cord from the power outlet before installing the memory to prevent hardware damage.
- Memory modules have a foolproof design. A memory module can be installed in only one direction. If you are unable to insert the memory, switch the direction.

3-6-1 Eight Channel Memory Configuration

This motherboard provides 32 DDR5 memory slots and supports 8-Channel Technology. After the memory is installed, the BIOS will automatically detect the specifications and capacity of the memory.

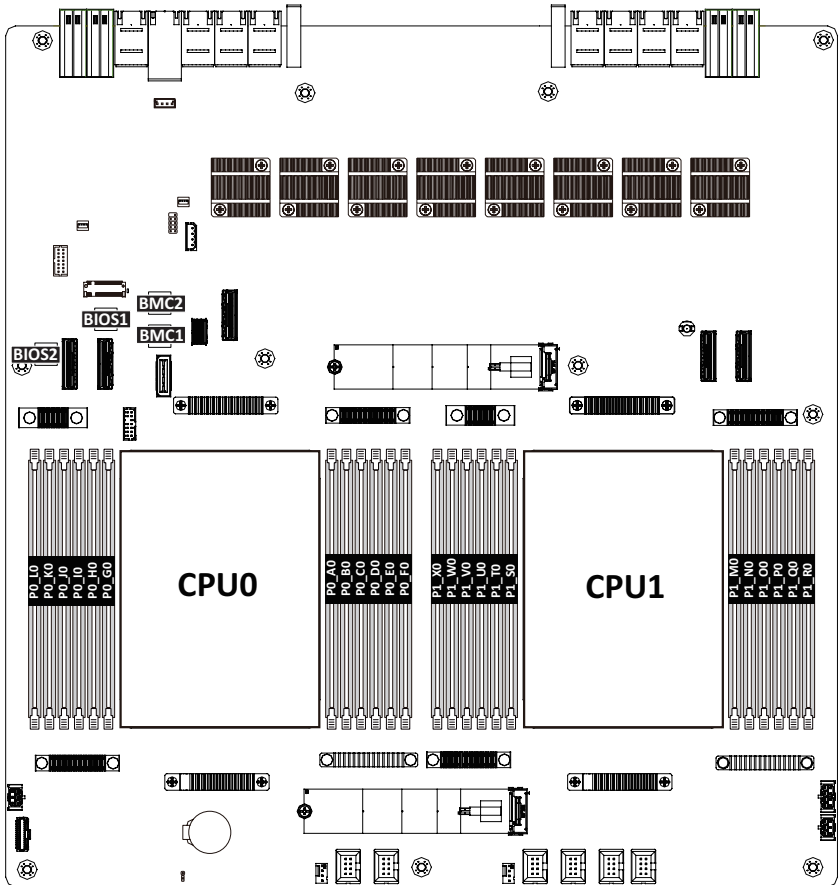

3-6-2 Installing the Memory



Before installing a memory module, make sure to turn off the computer and unplug the power cord from the power outlet to prevent damage to the memory module.

Be sure to install DDR5 DIMMs on this motherboard.

Make sure your DIMM slots have a single latch or a double latch.

Follow these instructions to install a DIMM module with Single Latch :

1. Open the plastic latch of the memory slot, then place the memory module as pre-inserted vertically position.

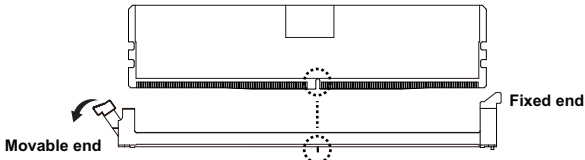

2. Hold it with both hands, insert the memory module into the movable end first, and then insert the memory module into the fixed end.

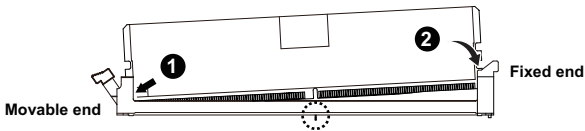

3. Then use both hands to insert the memory module vertically into the DIMM slot and push it down. Close the plastic latch at the edge of the DIMM slots to lock the memory module.

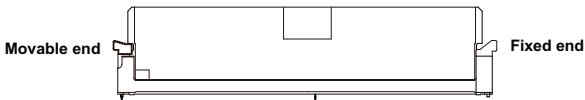

4. Reverse the installation steps when you want to remove the memory module.

Follow these instructions to install a DIMM module with Double Latch:

1. Insert the DIMM memory module vertically into the DIMM slot and push it down.
2. Close the plastic clip at both edges of the DIMM slots to lock the DIMM module.
3. Reverse the installation steps when you want to remove the DIMM module.

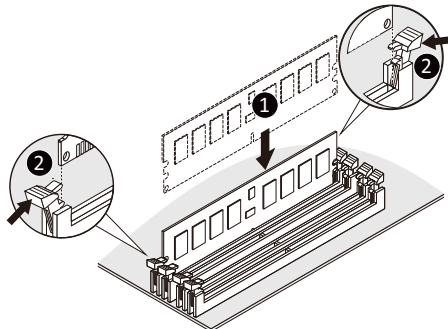

3-6-3 DIMM Population Table

Intel Xeon 6900E-Series Memory Support

Type	Ranks Per DIMM and Data Width	DIMM Capacity (GB)			Channel Speed (MT/s); Voltage (V); Slots per Channel (SPC) & DIMMs per Channel (DPC)
		DRAM Density			1DPC/2SPC
		16Gb	24Gb	32Gb	1.1V
RDIMM	1Rx4	32GB	48GB		6400, 6000, 5600, 5200, 4800 (DDR5-6400 rated RDIMMS only)
	2Rx4	64GB	96GB	128GB	
RDIMM 3DS	8Rx4	256GB			

Intel Xeon 6900E-Series CXL Memory Support

Native DDR5 Memory Per Socket				CXL Memory Per Socket				
Slot 0 DIMM Ranks	Slot 0 DIMM Capacity (GB)	DIMM Type	DRAM Density (Gb)	CXL Memory Channels	CXL Memory Type	CXL Capacity Per Device/ Module	CXL Interleave	CXL Mode
2Rx4	64	10x4	16	1+1	DDR5 x16	2ch 64 GB	Hetero x 16	Hetero
1Rx4	32	10x4	16	1+1+1	DDR5 x16	2ch 64 GB	1x3 (BIOS)	1LM+Intel® Flat Memory Mode

NOTE:

- Intel Xeon 6900E-series CXL memory configs are 1DPC only for native DDR5
- CXL Memory Channel notation: # of devices per root port, with root ports separated by "+". i.e. 2+2+2+2 = four root ports populated with two devices per root port
- CXL Interleave notation: sets x ways. i.e. 2x4 = two sets of four-way interleaves
- CXL Modes:
 - 1LM+Vol = DDR5 and CXL memory visible to SW as separate tiers, separately interleaved
 - Hetero = DDR5 and CXL memory interleaved together in one 16-way set
 - Flat2LM = HW manages data movement between DDR5 and CXL memory, total capacity visible to SW

Intel Xeon 6900P-Series Memory Support

Type	Ranks Per DIMM and Data Width	DIMM Capacity (GB)			Channel Speed (MT/s); Voltage (V); Slots per Channel (SPC) & DIMMs per Channel Density (DPC)
		DRAM Density			1DPC/1SPC
		16Gb	24Gb	32Gb	1.1V
RDIMM	1Rx4	32GB	48GB		6400, 6000, 5600, 5200, 4800 (DDR5-6400 rated RDIMMS only)
	2Rx8	32GB	48GB		
	2Rx4	64GB	96GB	128GB	
RDIMM 3DS	8Rx4	256GB			
MRDIMM	2Rx8	32GB			8800, 8000, 7200 (MRDIMM-8800 only)
	2Rx4	64GB	48GB		
	4Rx8	64GB	96GB	128GB	
	4Rx4 (2U)	128GB	96GB		
	4Rx4 (2U)			256GB	

Intel Xeon 6900P-Series CXL Memory Support

Native DDR5 Memory Per Socket				CXL Memory Per Socket				
Slot0 DIMM Ranks	Slot0 DIMM Capacity (GB)	DIMM Type	DRAM Density (Gb)	CXL Memory Channels	CXL Memory Type	CXL Capacity Per Device/ Module	CXL Interleave	CXL Mode
2Rx4	64	10x4	16	1+1	DDR5 x16	2ch 64 GB	hetero x16	Hetero
2Rx4	64	10x4	16	2+2+2+2	DDR5 x8	64 GB	1x8*, 2x4, 4x2	1LM+Vol
2Rx4	64	10x4	16	1+1+1	DDR4 x8	128 GB	1x3 (BIOS)	1LM+Intel® Flat Memory Mode

NOTE:

- Intel Xeon 6900P-series processors CXL memory configs are 1DPC only ('Slot 0') for native DDR5
- CXL Memory Channel notation: # of devices per root port, with root ports separated by "+". i.e. 2+2+2+2 = four root ports populated with two devices per root port
- CXL Interleave notation: sets x ways. i.e. 2x4 = Set of two modules, interleaved four-way
- CXL Modes:
 - 1LM+Vol = Native DDR5 ('1LM') and (volatile) CXL memory visible to SW as separate tiers, separately interleaved
 - Hetero x16 = DDR5 and (volatile) CXL memory interleaved together in one 16-way set (See graphic in next slide)
 - Flat Memory Mode = HW manages data movement between DDR5 and CXL memory, total capacity visible to SW

3-6-4 Processor and Memory Module Matrix Table

Memory Q'ty for each CPU	CPU0										CPU1													
	LO	KO	JO	IO	HO	GO	AO	BO	CO	DO	EO	FO	XO	WO	VO	UO	TO	SO	MO	NO	OO	PO	QO	RO
1 DIMM						v											v							
8 DIMM	v	v	v	v				v	v	v	v	v	v	v	v					v	v	v	v	
		v	v		v	v	v	v		v	v			v	v		v	v	v	v		v	v	
12 DIMM	v			v	v	v	v	v		v		v	v		v	v	v	v	v	v	v	v	v	
	v	v	v	v	v	v	v	v	v	v	v	v	v	v	v	v	v	v	v	v	v	v	v	v

3-7 Installing the PCI Expansion Card



- Voltages can be present within the server whenever an AC power source is connected. This voltage is present even when the main power switch is in the off position. Ensure that the system is powered-down and all power sources have been disconnected from the server prior to installing a PCIe card.
- Failure to observe these warnings could result in personal injury or damage to equipment.

Follow these instructions for a PCI Expansion card:

Left PCIe Card Cage

1. Loosen the thumbnail screw securing the handle of the PCIe card cage.
 2. Pull the cage out of the system.
 3. Remove the screw securing the slot cover to the riser bracket.
 4. Remove the slot cover from the riser bracket.
 5. Orient the PCIe card with the riser guide slot and push it towards the arrow until it is securely seated in the PCIe card connector.
- NOTE:** Some riser brackets allow for single or multiple PCIe cards.
Repeat steps 3-5 as necessary.
6. Secure the PCIe card with the screw.
 7. Reverse steps 1-2 to reinstall the PCIe card cage in position.

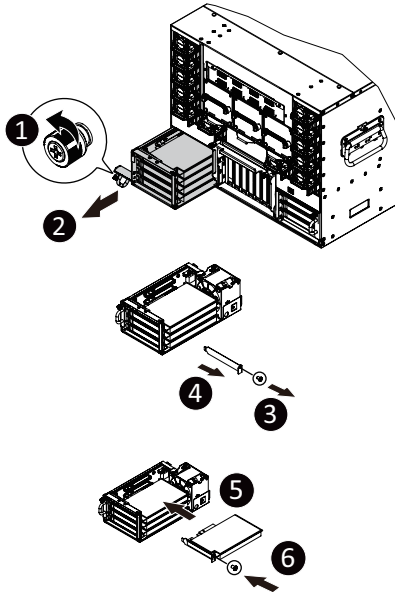

Right PCIe Card Cage

1. Loosen the thumbnail screw securing the handle of the PCIe card cage.
 2. Pull the cage out of the system.
 3. Remove the screws securing the MLAN tray, in the specified sequence.
 4. Lift the MLAN tray and remove it.
 5. Remove the screw securing the slot cover to the riser bracket.
 6. Remove the slot cover from the riser bracket.
 7. Orient the PCIe card with the riser guide slot and push it towards the arrow until it is securely seated in the PCIe card connector.
- NOTE:** Some riser brackets allow for single or multiple PCIe cards.
Repeat steps 5-7 as necessary.
8. Secure the PCIe card with the screw.
 9. Reverse steps 1-4 to reinstall the PCIe card cage in position.

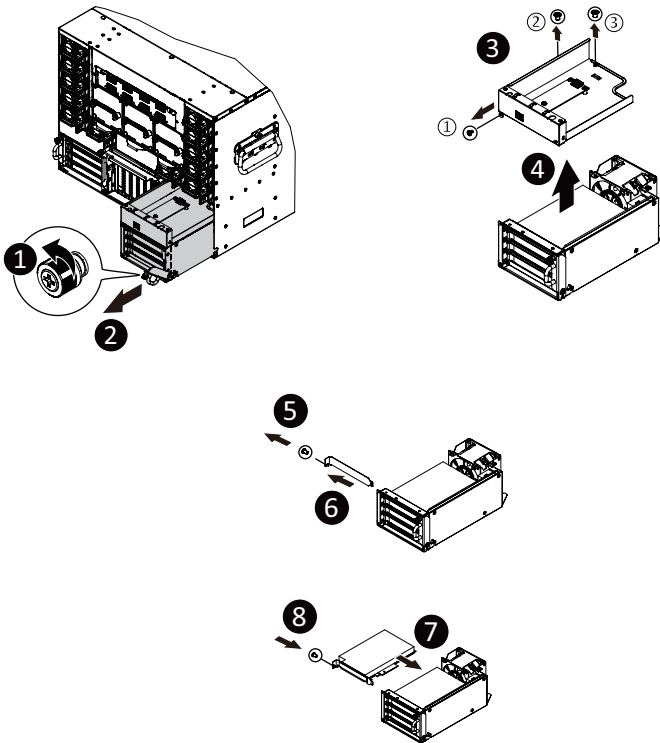

3-8 Installing the Hard Disk Drive



Read the following guidelines before you begin to install the hard disk drive:

- Take note of the drive tray orientation before sliding it out.
- The tray will not fit back into the bay if inserted incorrectly.
- Make sure that the hard disk drive is connected to the hard disk drive connector on the backplane.

Follow these instructions to install a 2.5" hard disk drive:

1. Press the release button.
2. Extend the locking lever.
3. Pull the locking lever in the direction indicated to remove the HDD tray.
4. Align the hard disk drive with the positioning stud on the HDD tray.
5. Slide the hard disk drive into the HDD tray.

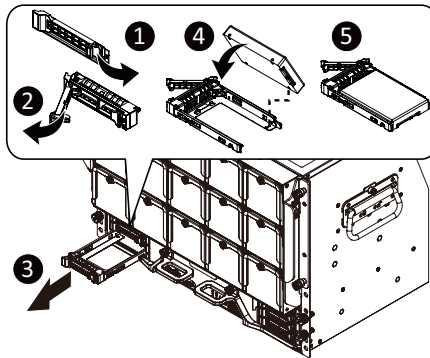

3-9 Installing the M.2 Device and Heat Sink



CAUTION

The position of the stand-off screw will depend on the size of the M.2 device. The stand-off screw is pre-installed for 22110 cards as standard. Refer to the size of the M.2 device and change the position of the stand-off screw accordingly.



WARNING:

Please ensure a heat sink is attached to any M.2 device installed into the system. Installing an M.2 device without any heat sink may result in the system overheating or system performance being throttled.



- To install/remove the M.2 module and Heat sink use a No. 1 Phillips-head screwdriver with a screw torque of $1.5 \pm 0.2 \text{ kgf}\cdot\text{cm}$

Follow these instructions to install the M.2 device and heat sink:

1. Insert the M.2 device into the M.2 connector.
2. Press down on the M.2 device.
3. Install the thermal pad of the M.2 device to the M.2 device.
4. Press down on the thermal pad.
5. Secure the M.2 device and its thermal pad to the motherboard with a single screw.
6. Reverse steps 1-2 to remove the M.2 device.

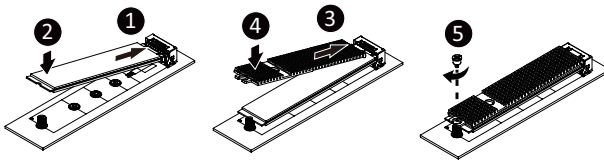

3-10 Replacing the System Fan Module



CAUTION!

Before you remove or install the system fans follow these steps:

- Disconnect all necessary cable connections. Failure to observe these warnings could result in personal injury or damage to the equipment

Follow these instructions to replace the GPU fan assembly:

1. Loosen the thumbnail screw securing the handle of the fan module.
2. Flip the handle and then grasp it firmly.
3. Pull out the fan module from the system.
4. Reverse the previous steps to install the replacement fan module.

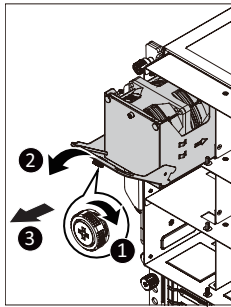

Follow these instructions to replace the fan assembly:

1. Flip and grasp the handle and simultaneously press the retaining clip on the bottom side of the fan module in the direction indicated.
2. Pull out the fan module from the system.
3. Reverse the previous steps to install the replacement fan module.

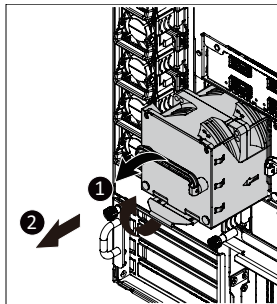

Internal System Fan

1. Remove the edge saddle by pulling it away from the fan assembly.
2. Lift the fan assembly from the chassis.
3. Reverse the previous steps to install the replacement fan assembly.

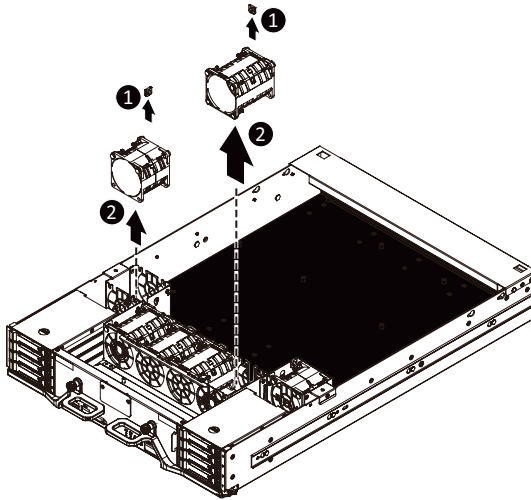

3-11 Removing and Installing the Power Supply



CAUTION!

Please see Section 2-2 "Rear View" for installation sequence.

Follow these instructions to replace the power supply:

1. Flip and then grasp the power supply handle.
2. Press the retaining clip on the right side of the power supply in the direction indicated.
3. Pull out the power supply using the handle.
4. Insert the replacement power supply firmly into the chassis. Connect the AC power cord to the replacement power supply.

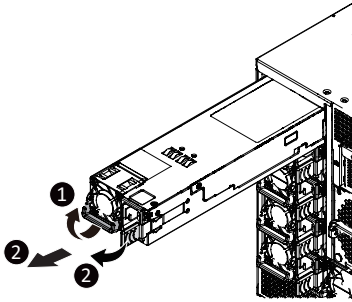

3-12 Installing the System into the Cabinet



Read the following guidelines before you begin to install the system into the cabinet:

- Make sure the system is not turned on or connected to AC power.
- A Lift Table is required. Place the system unit on Lift Table. **Recommended load capacity for the lift table: 200 kilograms.**
- Four Person lift required. Firmly hold the bottom of the system when required to lift and carry the system.
- Failure to observe these warnings could result in personal injury or damage to the equipment.

Follow these instructions to install the system into the cabinet:

1. Pull out and release the thumbnail screw securing the chassis handle in place.
2. Remove the four handles on each side of the system.
3. Carefully slide the system into the cabinet.

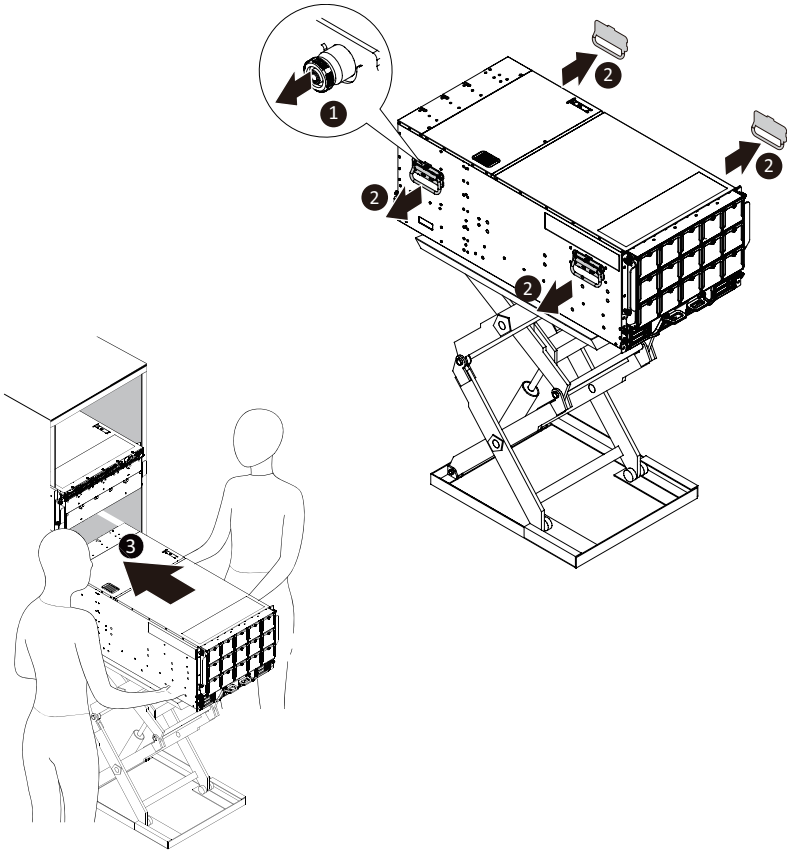

3-13 Removing the System from the Cabinet



Read the following guidelines before you begin to remove the system from the cabinet:

- Always turn off the computer and unplug the power cord from the power outlet before removing the system from the cabinet.
- Disconnect all necessary cable connections.
- A Lift Table is required. Place the system unit on Lift Table. **Recommended load capacity for the lift table: 200 kilograms.**
- Four Person lift required. Firmly hold the bottom of the system when required to lift and carry the system.
- Failure to observe these warnings could result in personal injury or damage to the equipment.

Follow these instructions to remove the system from the cabinet:

1. Loosen the thumbnail screws on each side that secure the system.
2. Gently pull out the system from the cabinet and place it on Lift table.

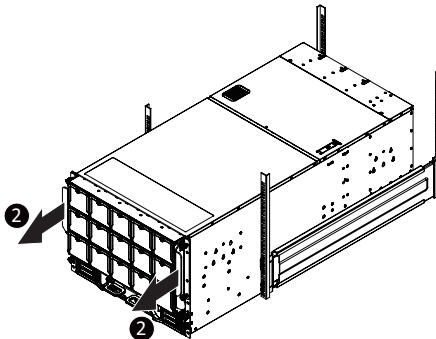
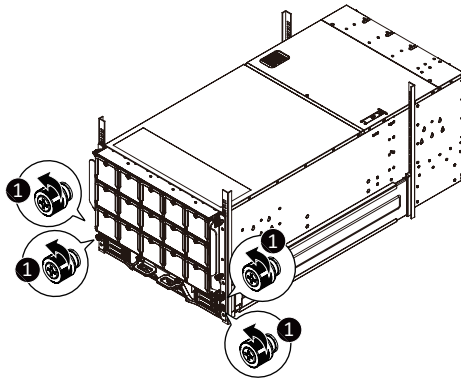

- NOTE!**
- The illustrations are for reference only.
 - The actual slide rail may vary depending on your purchase.

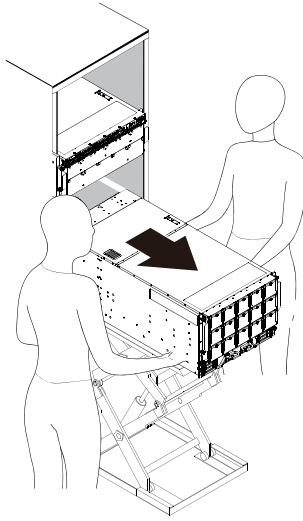

NOTE!

- Before lifting the system, installing the four chassis handles on the system is required.

Follow these instructions to install the chassis handles on the system:

1. Attach the four chassis handles to the system.
2. Push and lock the thumbnail screw to secure the chassis handle in place.

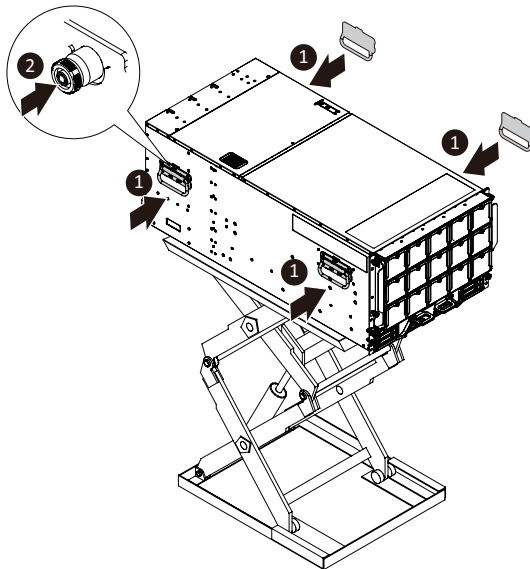

3-14 Cable Connection

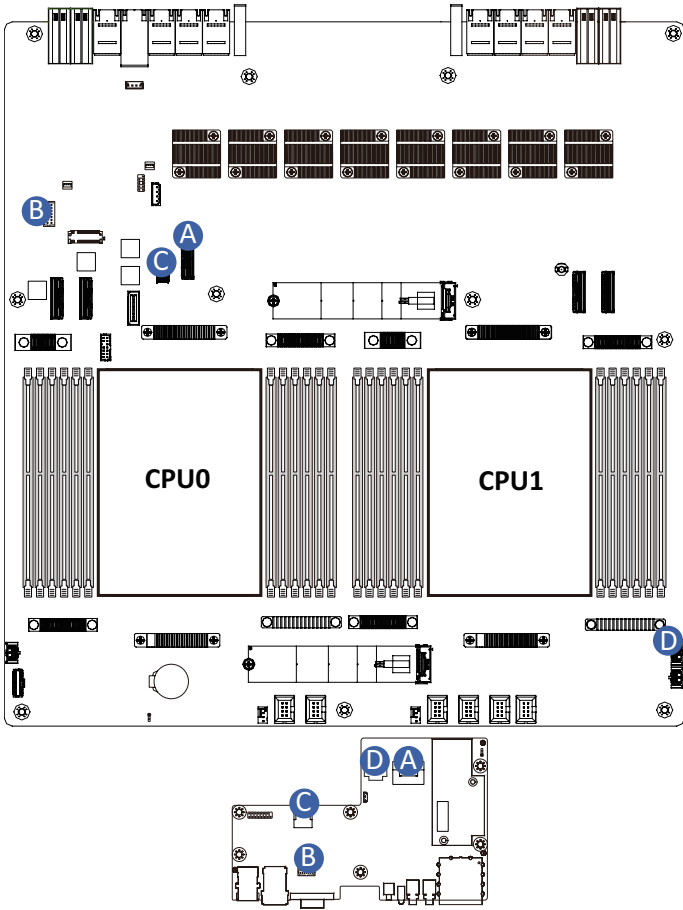

A	Front IO Board Signal Cable	Motherboard: FP_IO
		Front IO Board: FP_IO
B	Front IO VGA Cable	Motherboard: VGA_CON
		Front IO Board: VGA_CON
C	Front IO Board LAN Cable	Motherboard: FP_LAN
		Front IO Board: FP_LAN
D	Front IO Board Power Cable	Motherboard: FP_PWR
		Front IO Board: FP_PWR

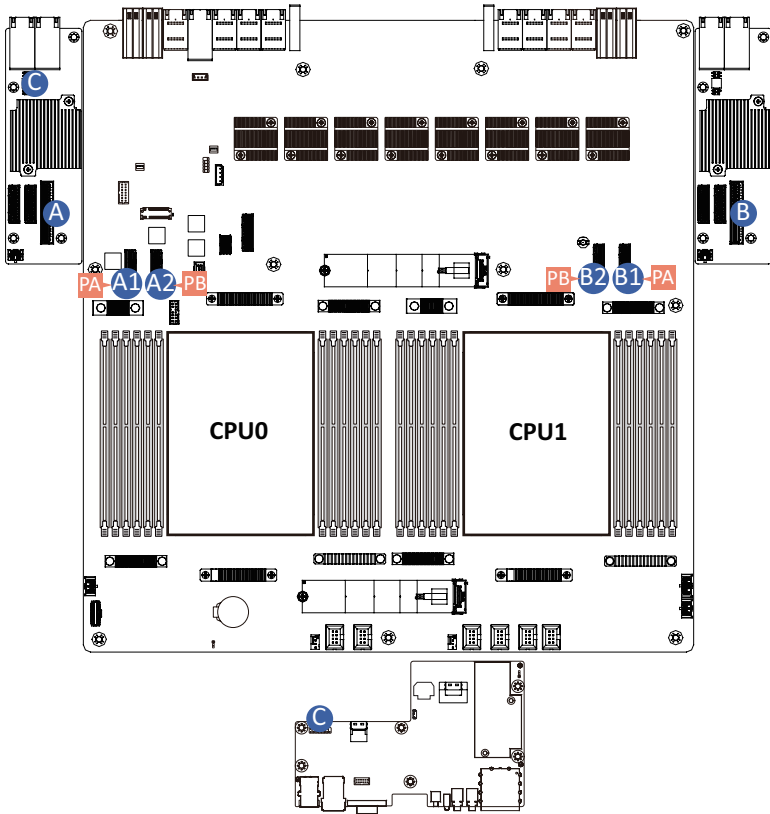

A	Rear LAN to Motherboard Signal Cable	Riser Switch Card (Left): U2_PE1
		Motherboard: A1: U2_P0_PE3A A2: U2_P0_PE3B
B	Rear LAN to Motherboard Signal Cable	Riser Switch Card (Right): U2_PE1
		Motherboard: B1: U2_P1_PE3A B2: U2_P1_PE3B
C	Rear LAN to Front IO LAN Signal Cable	Front IO Board: REAR_MLAN
		Riser Switch Card (Left): CN_LAN_F

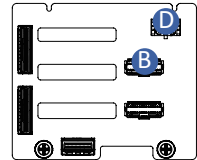
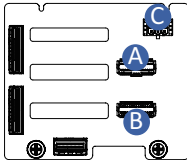
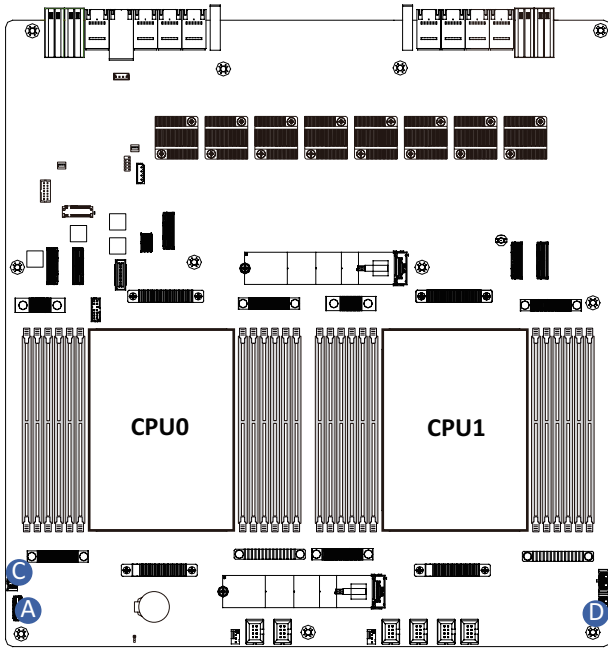

A	HDD Backplane Board Signal Cable	Motherboard: BP_1
		Front HDD Board: BP_1
B	HDD Backplane Board Signal Cable	Left Front HDD Board: BP_SERIES
		Right Front HDD Board: BP_1
C	HDD Backplane Board Power Cable	Motherboard: BPB_PWR1
		Left Front HDD Board: BP_PWR
D	HDD Backplane Board Power Cable	Motherboard: BPB_PWR2
		Right Front HDD Board: BP_PWR

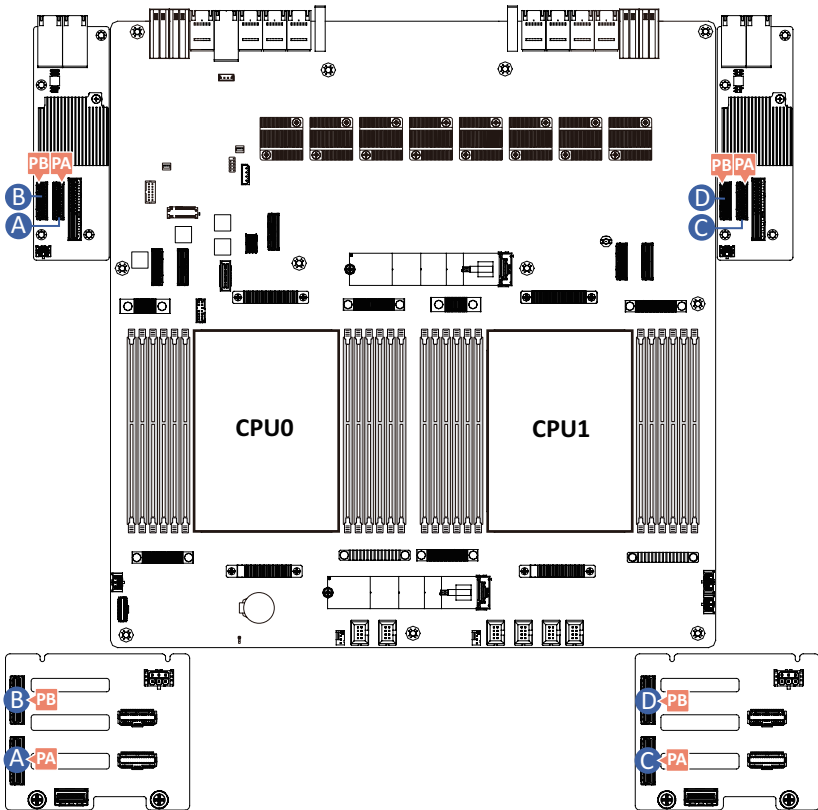

A	NVMe 0-1 Cable	Riser Switch Card (Left): MCIO0A	C	NVMe 4-5 Cable	Riser Switch Card (Right): MCIO0A
		Left Front HDD Board: U2_0			Right Front HDD Board: U2_0
B	NVMe 2-3 Cable	Riser Switch Card (Left): MCIO0B	D	NVMe 6-7 Cable	Riser Switch Card (Right): MCIO0B
		Left Front HDD Board: U2_1			Right Front HDD Board: U2_1

Chapter 4 Motherboard Components

4-1 Motherboard Components

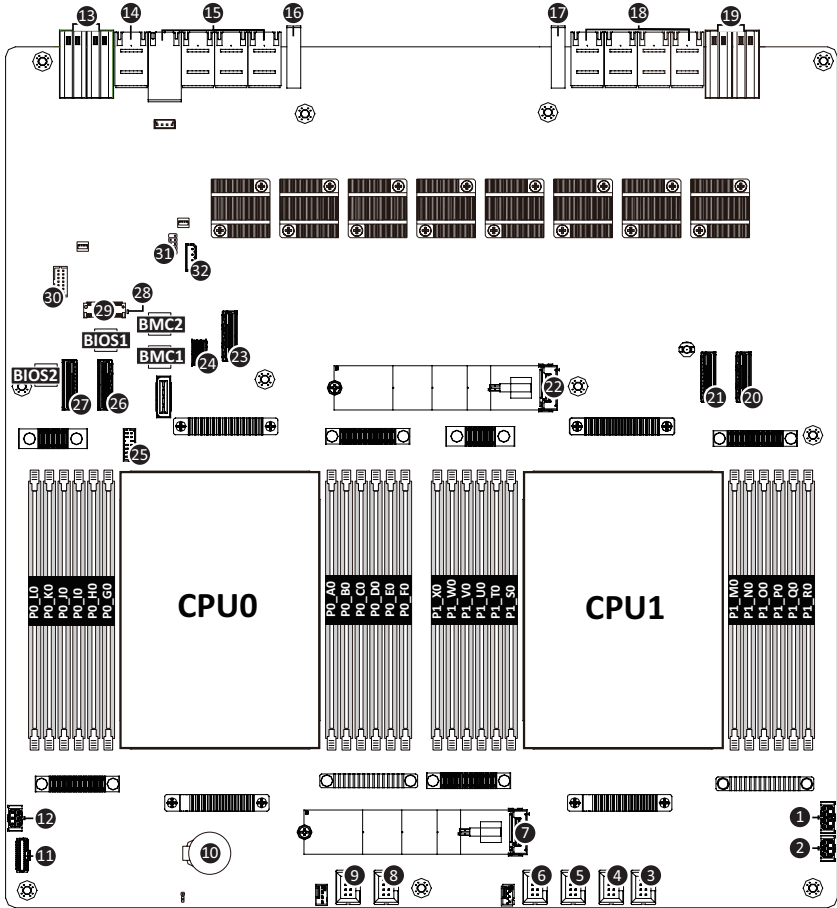

Item	Description
1	2 x 4 Pin Front Panel Power Connector (FP_PWR)
2	2 x 3 Backplane Power Connector (BPB_PWR2)
3	FAN_11/FAN_12 Connector
4	FAN_9/FAN_10 Connector
5	FAN_7/FAN_8 Connector
6	FAN_5/FAN_6 Connector
7	M.2 Slot (PCIe Gen5 x2, Support NGFF-22110)
8	FAN_3/FAN_4 Connector
9	FAN_1/FAN_2 Connector
10	Battery Socket
11	HDD Backplane Board Connector

Item	Description
12	2 x 3 Backplane Power Connector (BPB_PWR1)
13	Motherboard Power Connector (MB_PWR1/MB_PWR2)
14	Power Distribution Board Connector (PDB_IO)
15	PCIe Signal Connector (EX_SXMJ3-6)
16	Guide Pin Connector (GP1)
17	Guide Pin Connector (GP2)
18	PCIe Signal Connector (EX_SXMJ7-10)
19	Motherboard Power Connector (MB_PWR3/MB_PWR4)
20	MCIO Connector (U2_P1_PE3A/PCIe Gen5)
21	MCIO Connector (U2_P1_PE3B/PCIe Gen5)
22	M.2 Slot (PCIe Gen5 x4, Support NGFF-22110)
23	MCIO Connector (for System I/O/FP_IO)
24	SlimLine Connector (for MLAN/FP_LAN)
25	TPM Module Connector
26	MCIO Connector (U2_P0_PE3B/PCIe Gen5)
27	MCIO Connector (U2_P0_PE3A/PCIe Gen5)
28	BMC Firmware Readiness LED
29	PRoT Module Connector (M.2 M-Key/Optional SKU)
30	VGA Connector
31	Serial Port Header
32	IPMB Connector

4-2 Jumper Setting

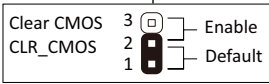
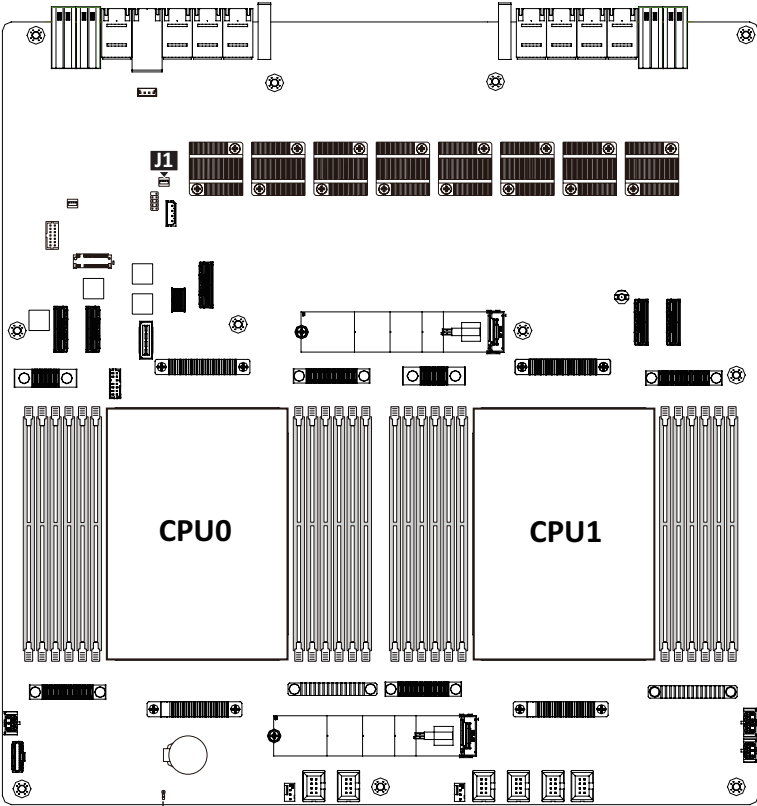

J1		ON	OFF
1	S3_MASK	Stop initial power on when BMC is not ready	Normal [Default]
2	BIOS_RCVR	BIOS recovery mode	Normal [Default]
3	BIOS_PWD	Clear supervisor password	Normal [Default]
4	RST BMC_EN	ID button to enable BMC reset	Normal [Default]

4-3 Backplane Board Storage Connector

4-3-1 CBPG641

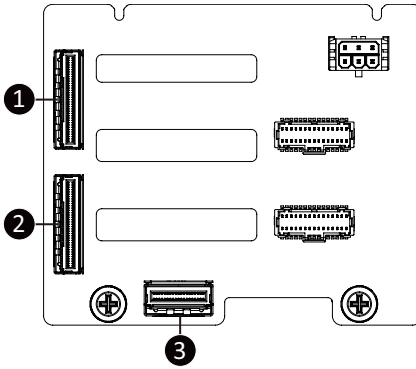

Item	Description
1.	MCIO 8i (SFF-TA-1016 / U2_1)
2.	MCIO 8i (SFF-TA-1016 / U2_0)
3.	MCIO 4i (SFF-TA-1016 / SL_CN1)

Chapter 5 BIOS Setup

BIOS (Basic Input and Output System) records hardware parameters of the system in the EFI on the motherboard. Its major functions include conducting the Power-On Self-Test (POST) during system startup, saving system parameters, loading the operating system etc. The BIOS includes a BIOS Setup program that allows the user to modify basic system configuration settings or to activate certain system features. When the power is turned off, the battery on the motherboard supplies the necessary power to the CMOS to keep the configuration values in the CMOS.

To access the BIOS Setup program, press the key during the POST when the power is turned on.



- BIOS flashing is potentially risky, if you do not encounter any problems when using the current BIOS version, it is recommended that you don't flash the BIOS. To flash the BIOS, do it with caution. Inadequate BIOS flashing may result in system malfunction.
- It is recommended that you not alter the default settings (unless you need to) to prevent system instability or other unexpected results. Inadequately altering the settings may result in system's failure to boot. If this occurs, try to clear the CMOS values and reset the board to default values. (Refer to the **Exit** section in this chapter or introductions of the battery/clearing CMOS jumper in Chapter 4 for how to clear the CMOS values.)

BIOS Setup Program Function Keys

<<-><->>	Move the selection bar to select the screen
<↑><↓>	Move the selection bar to select an item
<+>	Increase the numeric value or make changes
<->	Decrease the numeric value or make changes
<Enter>	Execute command or enter the submenu
<Esc>	Main Menu: Exit the BIOS Setup program Submenus: Exit current submenu
<F1>	Show descriptions of general help
<F3>	Restore the previous BIOS settings for the current submenus
<F9>	Load the Optimized BIOS default settings for the current submenus
<F10>	Save all the changes and exit the BIOS Setup program

■ **Main**

This setup page includes all the items of the standard compatible BIOS.

■ **Advanced**

This setup page includes all the items of AMI BIOS special enhanced features.

(ex: Auto detect fan and temperature status, automatically configure hard disk parameters.)

■ **Chipset**

This setup page includes all the submenu options for configuring the functions of the chipset.

■ **Server Management**

Server additional features enabled/disabled setup menus.

■ **Security**

Change, set, or disable supervisor and user password. Configuration supervisor password allows you to restrict access to the system and BIOS Setup.

A supervisor password allows you to make changes in BIOS Setup.

A user password only allows you to view the BIOS settings but not to make changes.

■ **Boot**

This setup page provides items for configuration of the boot sequence.

■ **Save & Exit**

Save all the changes made in the BIOS Setup program to the CMOS and exit BIOS Setup. (Pressing <F10> can also carry out this task.)

Abandon all changes and the previous settings remain in effect. Pressing <Y> to the confirmation message will exit BIOS Setup. (Pressing <Esc> can also carry out this task.)

5-1 The Main Menu

Once you enter the BIOS Setup program, the Main Menu (as shown below) appears on the screen. Use arrow keys to move among the items and press <Enter> to accept or enter other sub-menu.

Main Menu Help

The on-screen description of a highlighted setup option is displayed on the bottom line of the Main Menu.

Submenu Help

While in a submenu, press <F1> to display a help screen (General Help) of function keys available for the menu. Press <Esc> to exit the help screen. Help for each item is in the Item Help block on the right side of the submenu.



- When the system is not stable as usual, select the **Restore Defaults** item to set your system to its defaults.
- The BIOS Setup menus described in this chapter are for reference only and may differ by BIOS version.

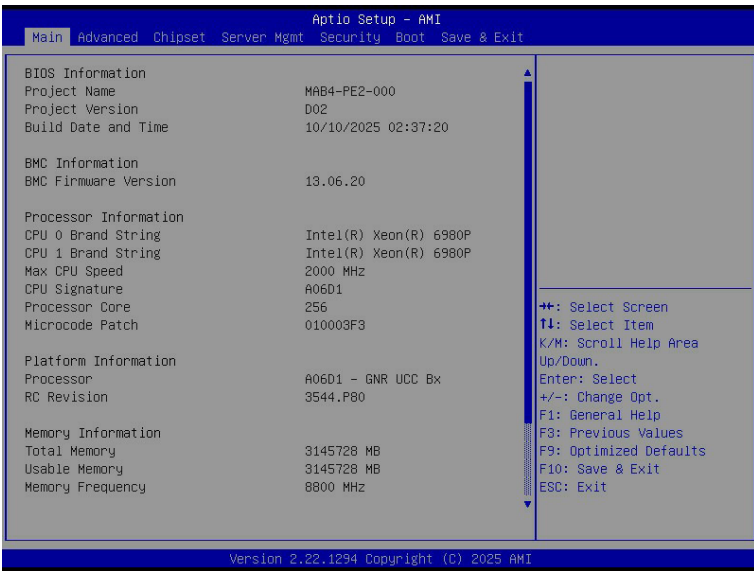

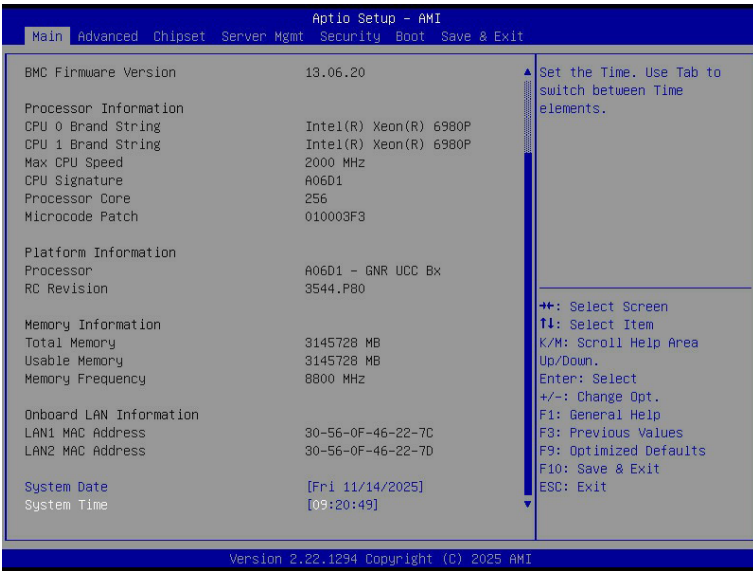

Parameter	Description
BIOS Information	
Project Name	Displays the project name information.
Project Version	Displays version number of the BIOS setup utility.
Build Date and Time	Displays the date and time when the BIOS setup utility was created.
BMC Information^(Note1)	
BMC Firmware Version ^(Note1)	Displays BMC firmware version information.
Processor Information	
CPU Brand String/ Max CPU Speed / CPU Signature / Processor Core / Microcode Patch	Displays the technical information for the installed processor(s).
Platform Information	
Processor/ RC Revision	Displays the information of the installed platform.
Memory Information^(Note2)	
Total Memory	Displays the total memory size of the installed memory.
Usable Memory	Displays the usable memory size of the installed memory.

(Note1) Functions available on selected models.

(Note2) This section will display capacity and frequency information of the memory that the customer has installed.

Parameter	Description
Memory Frequency	Displays the frequency information of the installed memory.
Onboard LAN Information ^(Note3)	
LAN# MAC Address	Displays LAN MAC address information.
System Date	Sets the date following the weekday-month-day-year format.
System Time	Sets the system time following the hour-minute-second format.

(Note3) The number of LAN ports listed will depend on the motherboard / system model.

5-2 Advanced Menu

The Advanced Menu displays submenu options for configuring the function of various hardware components. Select a submenu item, then press <Enter> to access the related submenu screen.

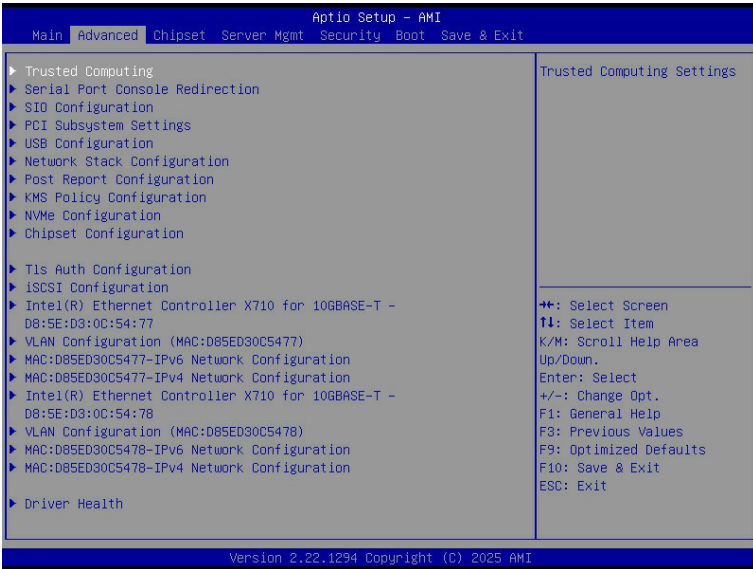

5-2-1 Trusted Computing



Parameter	Description
Configuration	
TPM v1.2 Support	Enable/Disable BIOS support for security device. OS will not show security device. TCG EFI protocol and INT1A interface will not be available. Options available: Disabled, Enabled .

5-2-2 Serial Port Console Redirection

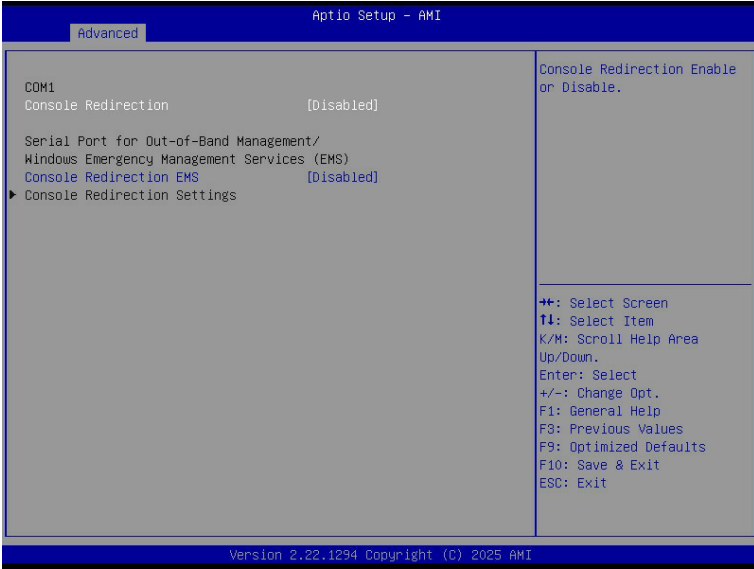

Parameter	Description
COM1 Console Redirection ^(Note)	<p>Console redirection enables the users to manage the system from a remote location.</p> <p>Options available: Enabled, Disabled.</p>
COM1 Console Redirection Settings	<p>Press [Enter] to configure advanced items.</p> <p>Please note that this item is configurable when COM1 Console Redirection is set to Enabled.</p> <ul style="list-style-type: none"> ◆ Terminal Type <ul style="list-style-type: none"> – Selects a terminal type to be used for console redirection. – Options available: VT100, VT100PLUS, VT-UTF8, ANSI. ◆ Bits per second <ul style="list-style-type: none"> – Selects the transfer rate for console redirection. – Options available: 9600, 19200, 38400, 57600, 115200. ◆ Data Bits <ul style="list-style-type: none"> – Selects the number of data bits used for console redirection. – Options available: 7, 8.

(Note) Advanced items prompt when this item is defined.

Parameter	Description
COM1 Console Redirection Settings (continued)	<ul style="list-style-type: none"> ◆ Parity <ul style="list-style-type: none"> – A parity bit can be sent with the data bits to detect some transmission errors. – Even: parity bit is 0 if the num of 1's in the data bits is even. – Odd: parity bit is 0 if num of 1's in the data bits is odd. – Mark: parity bit is always 1. Space: Parity bit is always 0. – Mark and Space Parity do not allow for error detection. – Options available: None, Even, Odd, Mark, Space. ◆ Stop Bits <ul style="list-style-type: none"> – Stop bits indicate the end of a serial data packet. (A start bit indicates the beginning). The standard setting is 1 stop bit. Communication with slow devices may require more than 1 stop bit. – Options available: 1, 2. ◆ Flow Control <ul style="list-style-type: none"> – Flow control can prevent data loss from buffer overflow. When sending data, if the receiving buffers are full, a 'stop' signal can be sent to stop the data flow. Once the buffers are empty, a 'start' signal can be sent to re-start the flow. Hardware flow control uses two wires to send start/stop signals. – Options available: None, Hardware RTS/CTS. ◆ VT-UTF8 Combo Key Support <ul style="list-style-type: none"> – Enable/Disable the VT-UTF8 Combo Key Support. – Options available: Enabled, Disabled. ◆ Recorder Mode <ul style="list-style-type: none"> – When this mode enabled, only texts will be send. This is to capture Terminal data. – Options available: Enabled, Disabled. ◆ Resolution 100x31 <ul style="list-style-type: none"> – Enable/Disable extended terminal resolution. – Options available: Enabled, Disabled. ◆ Putty KeyPad <ul style="list-style-type: none"> – Selects Function Key and KeyPad on Putty. – Options available: VT100, LINUX, XTERMR6, SC0, ESCN, VT400.
Serial Port for Out-of-Band Management / Windows Emergency Management Services (EMS) Console Redirection ^(Note)	<p>EMS console redirection allows the user to configure Console Redirection Settings to support Out-of-Band Serial Port management.</p> <p>Options available: Enabled, Disabled.</p>

Parameter	Description
Serial Port for Out-of-Band EMS Console Redirection Settings	<p data-bbox="362 158 692 181">Press [Enter] to configure advanced items.</p> <p data-bbox="362 185 942 241">Please note that this item is configurable when Serial Port for Out-of-Band Management EMS Console Redirection is set to Enabled.</p> <ul style="list-style-type: none"> <li data-bbox="362 249 948 388">◆ Out-of-Band Mgmt Port <ul style="list-style-type: none"> <li data-bbox="400 280 948 362">– Microsoft Windows Emergency Management Service (EMS) allows for remote management of a Windows Server OS through a serial port. <li data-bbox="400 365 614 388">– Default setting is COM1. <li data-bbox="362 396 873 478">◆ Terminal Type EMS <ul style="list-style-type: none"> <li data-bbox="400 428 873 451">– Selects a terminal type to be used for console redirection. <li data-bbox="400 454 868 478">– Options available: VT100, VT100PLUS, VT-UTF8, ANSI. <li data-bbox="362 486 799 567">◆ Bits per second EMS <ul style="list-style-type: none"> <li data-bbox="400 517 793 540">– Selects the transfer rate for console redirection. <li data-bbox="400 544 799 567">– Options available: 9600, 19200, 57600, 115200. <li data-bbox="362 575 937 769">◆ Flow Control EMS <ul style="list-style-type: none"> <li data-bbox="400 606 937 746">– Flow control can prevent data loss from buffer overflow. When sending data, if the receiving buffers are full, a 'stop' signal can be sent to stop the data flow. Once the buffers are empty, a 'start' signal can be sent to re-start the flow. Hardware flow control uses two wires to send start/stop signals. <li data-bbox="400 749 937 769">– Options available: None, Hardware RTS/CTS, Software Xon/Xoff.

5-2-3 SIO Configuration

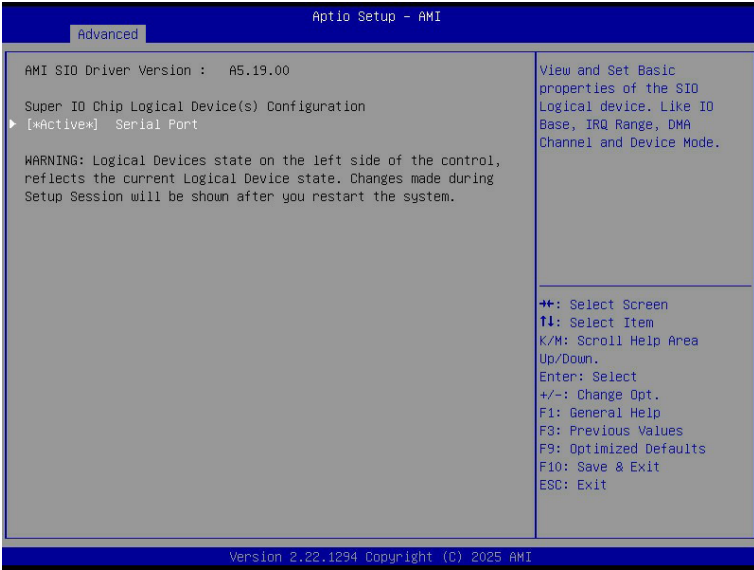

Parameter	Description
AMI SIO Driver Version	Displays the AMI SIO driver version information.
Super IO Chip Logical Device(s) Configuration	Press [Enter] to configure advanced items.
[*Active*] Serial Port	<ul style="list-style-type: none"> ◆ Use This Device <ul style="list-style-type: none"> – When set to Enabled allows you to configure the serial port settings. When set to Disabled, displays no configuration for the serial port. – Options available: Enabled, Disabled. ◆ Logical Device Settings/Current: <ul style="list-style-type: none"> – Displays the serial port base I/O address and IRQ. ◆ Possible: <ul style="list-style-type: none"> – Configures the serial port base I/O address and IRQ. – Options available: <ul style="list-style-type: none"> Use Automatic Settings IO=3F8h; IRQ=4; DMA; IO=3F8h; IRQ=3, 4, 5, 7, 9, 10, 11, 12; DMA; IO=2F8h; IRQ=3, 4, 5, 7, 9, 10, 11, 12; DMA; IO=3E8h; IRQ=3, 4, 5, 7, 9, 10, 11, 12; DMA; IO=2E8h; IRQ=3, 4, 5, 7, 9, 10, 11, 12; DMA;

5-2-4 PCI Subsystem Settings

Aptio Setup - AMI

Advanced

PCI Bus Driver Version	A5.01.32	Enable/Disable SLOT1 I/O ROM RTM2_SXM1 I/O ROM [Enabled] SLOT2 I/O ROM [Enabled] SLOT3 I/O ROM [Enabled] SLOT4 I/O ROM [Enabled] LAN I/O ROM [Enabled] LAN Lanes [Auto] LAN Max Link Speed [Auto] RTM2_SXM1 I/O ROM [Enabled] RTM2_SXM1 Lanes [Auto] RTM2_SXM1 Max Link Speed [Auto] RTM1_SXM2 I/O ROM [Enabled] RTM1_SXM2 Lanes [Auto] RTM1_SXM2 Max Link Speed [Auto] RTM3_SXM3 I/O ROM [Enabled] RTM3_SXM3 Lanes [Auto] RTM3_SXM3 Max Link Speed [Auto]
SLOT1 I/O ROM	[Enabled]	
SLOT2 I/O ROM	[Enabled]	
SLOT3 I/O ROM	[Enabled]	
SLOT4 I/O ROM	[Enabled]	
LAN I/O ROM	[Enabled]	
LAN Lanes	[Auto]	
LAN Max Link Speed	[Auto]	
RTM2_SXM1 I/O ROM	[Enabled]	
RTM2_SXM1 Lanes	[Auto]	
RTM2_SXM1 Max Link Speed	[Auto]	
RTM1_SXM2 I/O ROM	[Enabled]	
RTM1_SXM2 Lanes	[Auto]	
RTM1_SXM2 Max Link Speed	[Auto]	
RTM3_SXM3 I/O ROM	[Enabled]	++: Select Screen T1: Select Item K/M: Scroll Help Area Up/Down. Enter: Select +/-: Change Opt. F1: General Help F8: Previous Values F9: Optimized Defaults F10: Save & Exit ESC: Exit
RTM3_SXM3 Lanes	[Auto]	
RTM3_SXM3 Max Link Speed	[Auto]	

Version 2.22.1294 Copyright (C) 2025 AMI

Aptio Setup - AMI

Advanced

RTM7_SXM7 I/O ROM	[Enabled]	If system has SR-IOV capable PCIe Devices, this option Enables or Disables Single Root ID Virtualization Support. ++: Select Screen T1: Select Item K/M: Scroll Help Area Up/Down. Enter: Select +/-: Change Opt. F1: General Help F8: Previous Values F9: Optimized Defaults F10: Save & Exit ESC: Exit
RTM7_SXM7 Lanes	[Auto]	
RTM7_SXM7 Max Link Speed	[Auto]	
RTM4_SXM8 I/O ROM	[Enabled]	
RTM4_SXM8 Lanes	[Auto]	
RTM4_SXM8 Max Link Speed	[Auto]	
M2_0 I/O ROM	[Enabled]	
M2_0 Lanes	[Auto]	
M2_0 Max Link Speed	[Auto]	
M2_1 I/O ROM	[Enabled]	
M2_1 Max Link Speed	[Auto]	
Onboard LAN1 & LAN2 Controller	[Enabled]	
Onboard LAN1 I/O ROM	[Enabled]	
Onboard LAN2 I/O ROM	[Enabled]	
PCI Devices Common Settings:		
Re-Size BAR Support	[Disabled]	
SR-IOV Support	[Enabled]	

Version 2.22.1294 Copyright (C) 2025 AMI

Parameter	Description
PCI Bus Driver Version	Displays the PCI Bus Driver version information.
SLOT_# I/O ROM ^(Note1)	When enabled, this setting will initialize the device expansion ROM for the related PCIe slot. Options available: Enabled , Disabled.
LAN I/O ROM	When enabled, this setting will initialize the device expansion ROM for the related LAN PCIe slot. Options available: Enabled , Disabled.
LAN Lanes	Change LAN PCIe lanes. Options available: Auto , x4, x2x2.
LAN Max Link Speed	Change LAN max link speed. Options available: Auto , Gen1, Gen2, Gen3, Gen4, Gen5.
RTM#_SXM# I/O ROM ^(Note2)	When enabled, this setting will initialize the device expansion ROM for the related GPU slot. Options available: Enabled , Disabled.
RTM#_SXM# Lanes	Change RTM#_SXM# PCIe lanes. Default setting is Auto .
RTM#_SXM# Max Link Speed	Change RTM#_SXM# max link speed. Options available: Auto , Gen1, Gen2, Gen3, Gen4, Gen5.
M2_# I/O ROM ^(Note3)	When enabled, this setting will initialize the device expansion ROM for the related M2 slot. Options available: Enabled , Disabled.
M2_0 Lanes	Change M2_0 PCIe lanes. Options available: Auto , x4, x2x2.
M2_# Max Link Speed	Change M2_# max link speed. Options available: Auto , Gen1, Gen2, Gen3, Gen4, Gen5.
Onboard LAN# Controller ^(Note4)	Enable/Disable the onboard LAN controller. Options available: Disabled, Enabled .
Onboard LAN# I/O ROM ^(Note4)	Enable/Disable the onboard LAN devices, and initializes device expansion ROM. Options available: Disabled, Enabled .
PCI Devices Common Settings	
Re-Size BAR Support	If system has Resizable BAR capable PCIe Devices, this option Enables or Disables Resizable BAR Support. Options available: Disabled , Enabled.
SR-IOV Support	If the system has SR-IOV capable PCIe devices, this item Enable/Disable Single Root IO Virtualization Support. Options available: Disabled, Enabled .

(Note1) This section is dependent on the available PCIe Slot.

(Note2) This section is dependent on the available GPU Module.

(Note3) This section is dependent on the available M2 Slot.

(Note4) This section is dependent on the available LAN controller.

5-2-5 USB Configuration

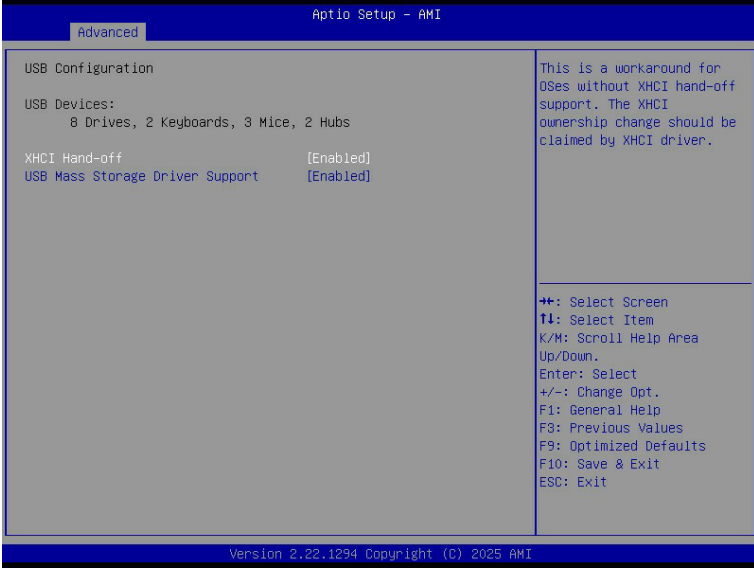

Parameter	Description
USB Configuration	
USB Devices:	Displays the USB devices connected to the system.
XHCI Hand-off	Enable/Disable the XHCI (USB 3.0) Hand-off support. Options available: Enabled , Disabled.
USB Mass Storage Driver Support ^(Note)	Enable/Disable the USB Mass Storage Driver Support. Options available: Enabled , Disabled.

(Note) This item is present only if you attach USB devices.

5-2-6 Network Stack Configuration

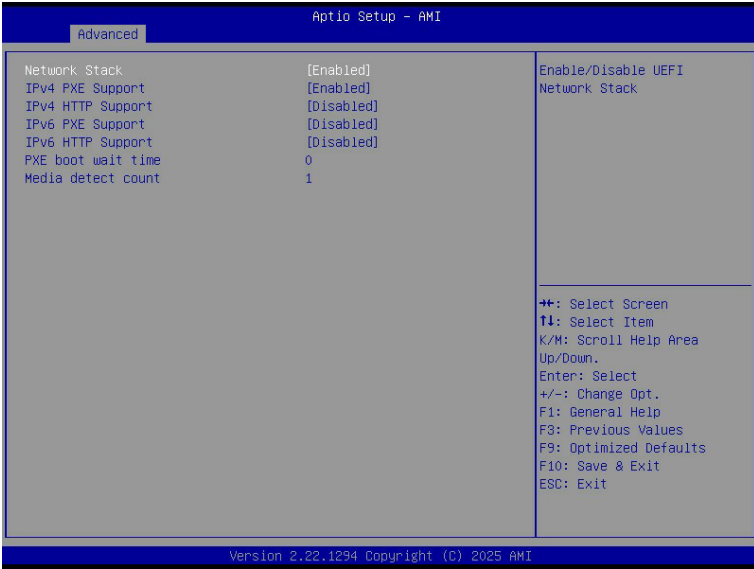

Parameter	Description
Network Stack	Enable/Disable the UEFI network stack. Options available: Enabled , Disabled.
Ipv4 PXE Support	Enable/Disable the Ipv4 PXE feature. Options available: Enabled , Disabled.
Ipv4 HTTP Support	Enable/Disable the Ipv4 HTTP feature. Options available: Enabled, Disabled .
Ipv6 PXE Support	Enable/Disable the Ipv6 PXE feature. Options available: Enabled, Disabled .
Ipv6 HTTP Support	Enable/Disable the Ipv6 HTTP feature. Options available: Enabled, Disabled .
PXE boot wait time	Wait time in seconds to press ESC key to abort the PXE boot. Press the <+> / <-> keys to increase or decrease the desired values.
Media detect count	Number of times the presence of media will be checked. Press the <+> / <-> keys to increase or decrease the desired values.

5-2-7 Post Report Configuration

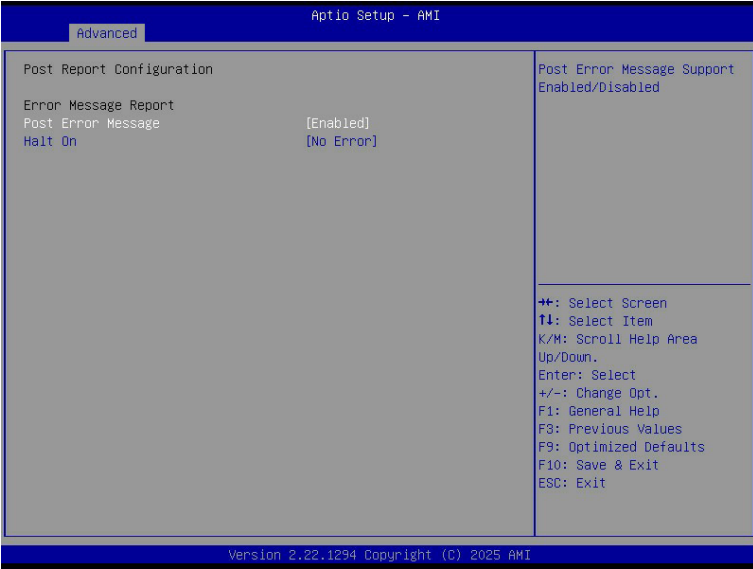

Parameter	Description
Post Report Configuration	
Error Message Report	
Post Error Message	Enable/Disable the POST Error Message support. Options available: Disabled, Enabled .
Halt On	Options available: No Error , All Error.

5-2-8 KMS Policy Configuration

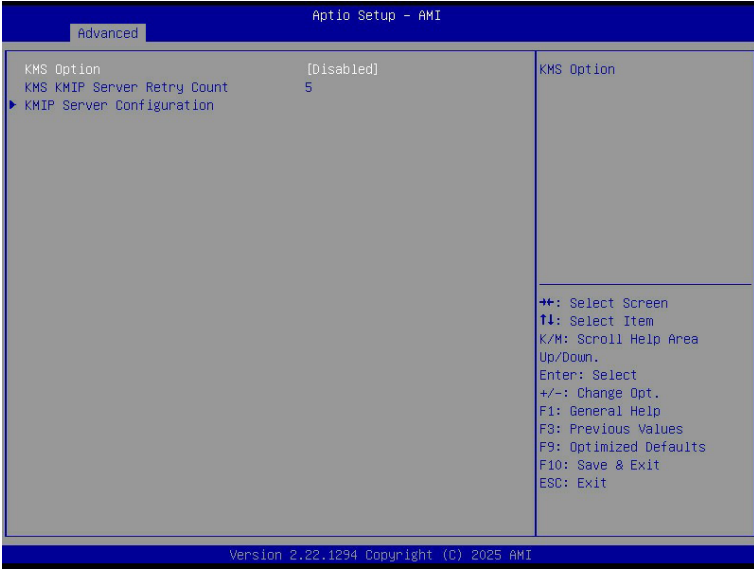

Parameter	Description
KMS Option	Options available: Disabled , KMS with KMIP.
KMS KMIP Server Retry Count	Define KMS KMIP Server Retry Count.
KMIP Server Configuration	<p>Press [Enter] to configure advanced items.</p> <ul style="list-style-type: none"> ◆ KMIP Server IP address <ul style="list-style-type: none"> – Enter IP4 address in dotted-decimal notation. ◆ KMIP TCP Port number <ul style="list-style-type: none"> – Enter KMIP TCP Port number 100...9999. – Default setting is 5696. ◆ Time Zone <ul style="list-style-type: none"> – Enter the correct time zone for this server. – Default setting is GMT+8. ◆ Client Credentials <ul style="list-style-type: none"> – Use User and password credentials to authenticate the client. – Options available: Disabled, Enabled. ◆ Client UserName <ul style="list-style-type: none"> – Enter Client identity: UserName. – Name Length: 0-63 characters. ◆ Client Password <ul style="list-style-type: none"> – Enter Client identity: Password. – Password Length: 0-31 characters.

Parameter	Description
KMIP Server Configuration (continued)	<ul style="list-style-type: none">♦ KMS TLS Certificate / Size<ul style="list-style-type: none">- CA Certificate/ Client Private Key/ Client Certificate.<ul style="list-style-type: none">» Enroll factory defaults or load the KMS TLS certificates from the file.

5-2-9 NVMe Configuration

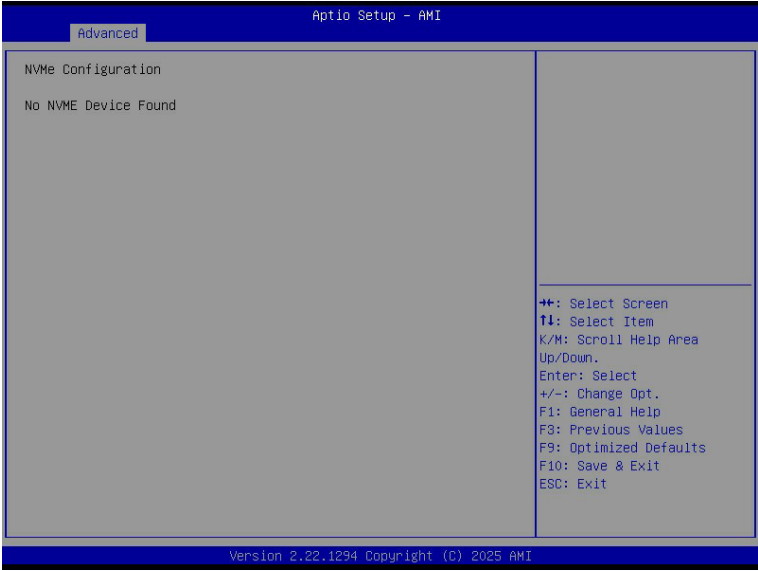

Parameter	Description
NVMe Configuration	Displays the NVMe devices connected to the system.

5-2-10 Chipset Configuration

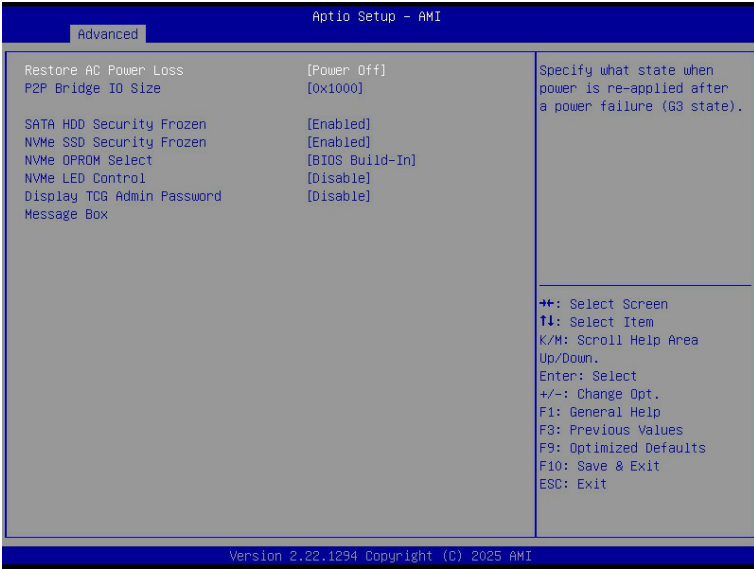

Parameter	Description
Restore on AC Power Loss ^(Note)	Defines the power state to resume to after a system shutdown that is due to an interruption in AC power. When set to Last State, the system will return to the active power state prior to shutdown. When set to Power Off, the system remains off after power shutdown. Options available: Last State, Power Off, Power On, Unspecified. The default setting depends on the BMC setting.
P2P Bridge IO Size	Specifies P2P Bridge IO aligned to the size. Options available: 0x100, 0x150, 0x1000 .
SATA HDD Security Frozen	Enable/Disable this item to send freeze lock command to SATA HDD. Options available: Disabled, Enabled .
NVMe SSD Security Frozen	Attempt to send freeze lock command to NVMe SSDs during boot. Options available: Disabled, Enabled .
NVMe OPROM Select	Options available: BIOS Build-In , NVMe Device, Disabled.
NVMe LED Control	Enable/Disable allow user control NVMe LED. It only available the NVMe device direct connect to CPU. Options available: Disable , Enable.
Display TCG Admin Password Message Box	Enable/Disable allow user control TCG Admin Password Message Box at POST or not. Options available: Disable , Enable.

(Note) When the power policy is controlled by BMC, please wait for 15-20 seconds for BMC to save the last power state.

5-2-11 Tls Auth Configuration

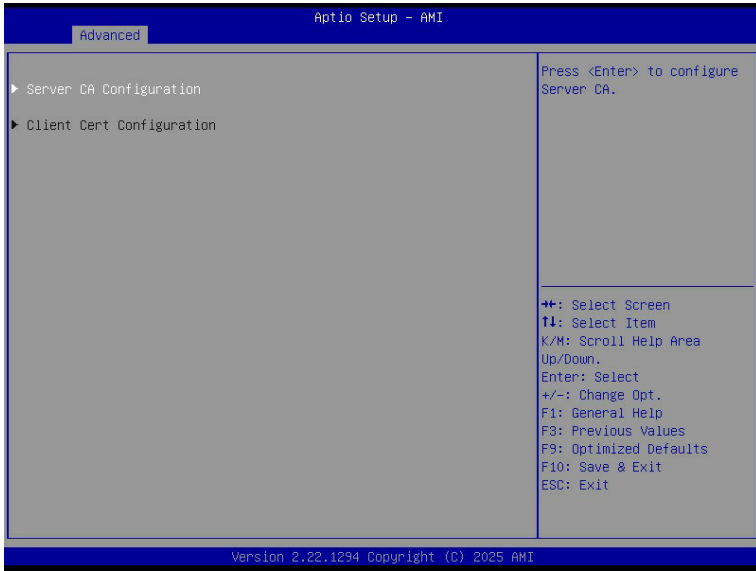

Parameter	Description
Server CA Configuration	<p>Press [Enter] for configuration of advanced items.</p> <ul style="list-style-type: none"> ◆ Enroll Cert <ul style="list-style-type: none"> – Press [Enter] to enroll a certificate <ul style="list-style-type: none"> • Enroll Cert Using File • Cert GUID <ul style="list-style-type: none"> Input digit character in 1111111-2222-3333-4444-1234567890ab format. – Commit Changes and Exit – Discard Changes and Exit ◆ Delete Cert
Client Cert Configuration	Press [Enter] for configuration of advanced items.

5-2-12 iSCSI Configuration

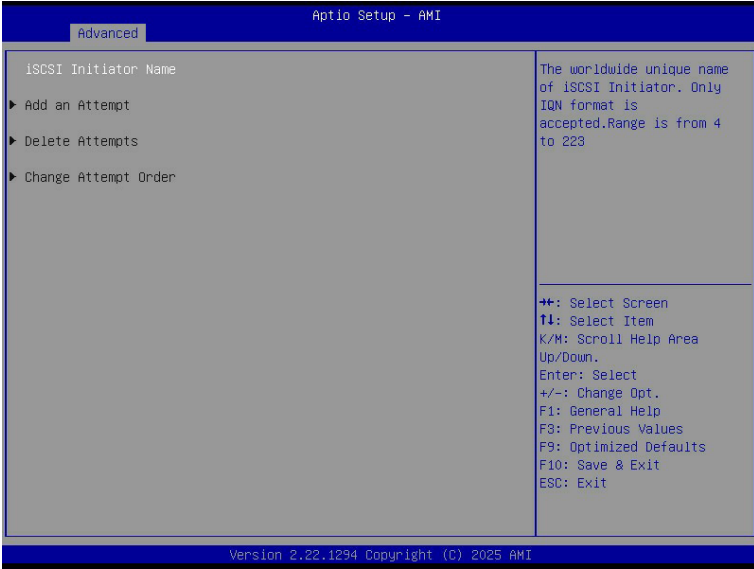

Parameter	Description
Attempt Priority	<p>Press [Enter] configure advanced items.</p> <ul style="list-style-type: none"> ◆ Attempt Priority <ul style="list-style-type: none"> – Use arrow keys to select the attempt, then press +/- keys to move the attempt up/down in the attempt order list. ◆ Commit Changes and Exit
Host iSCSI Configuration	<p>Press [Enter] to configure advanced items.</p> <ul style="list-style-type: none"> ◆ iSCSI Initiator Name <ul style="list-style-type: none"> – Only IQN format is accepted. Range: from 4 to 223 ◆ Add an Attempt ◆ Delete Attempts ◆ Change Attempt Order

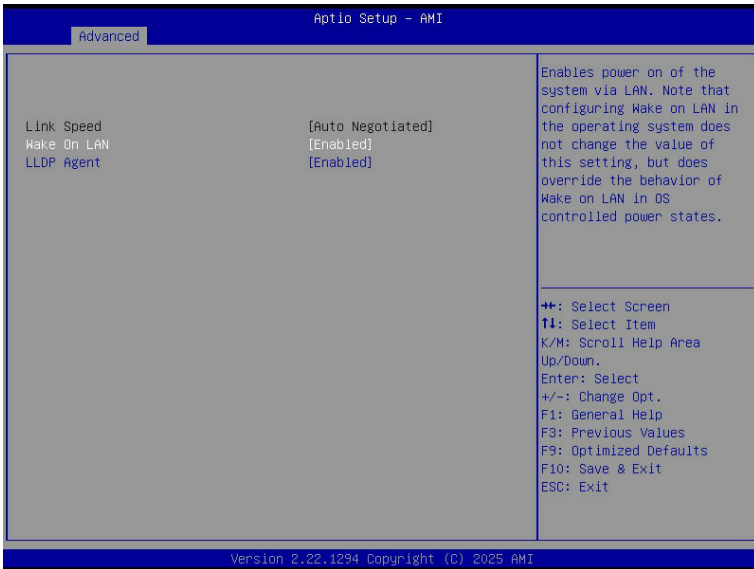

Parameter	Description
Firmware Image Properties	Press [Enter] to view device firmware version information
NIC Configuration	<p>Press [Enter] to configure advanced items.</p> <ul style="list-style-type: none"> ◆ Link Speed <ul style="list-style-type: none"> – Allows for automatic link speed adjustment. – Default setting is Auto Negotiated. ◆ Wake On LAN <ul style="list-style-type: none"> – Enables power on of the system via LAN. Note that configuring Wake on LAN in the operating system does not change the value of this setting, but does override the behavior of Wake on LAN in OS controlled power states. – Options available: Disabled, Enabled. ◆ LLDP Agent <ul style="list-style-type: none"> – Options available: Disabled, Enabled.
Blink LEDs	Identifies the physical network port by blinking the associated LED. Press the numeric keys to adjust desired values (up to 15 seconds).
UEFI Driver	Displays the technical specifications for the Network Interface Controller.
Adapter PBA	Displays the technical specifications for the Network Interface Controller.
Device Name	Displays the technical specifications for the Network Interface Controller.
Chip Type	Displays the technical specifications for the Network Interface Controller.
PCI Device ID	Displays the technical specifications for the Network Interface Controller.
PCI Address	Displays the technical specifications for the Network Interface Controller.
Link Status	Displays the technical specifications for the Network Interface Controller.

Parameter	Description
MAC Address	Displays the technical specifications for the Network Interface Controller.
Virtual MAC Address	Displays the technical specifications for the Network Interface Controller.

5-2-14 VLAN Configuration

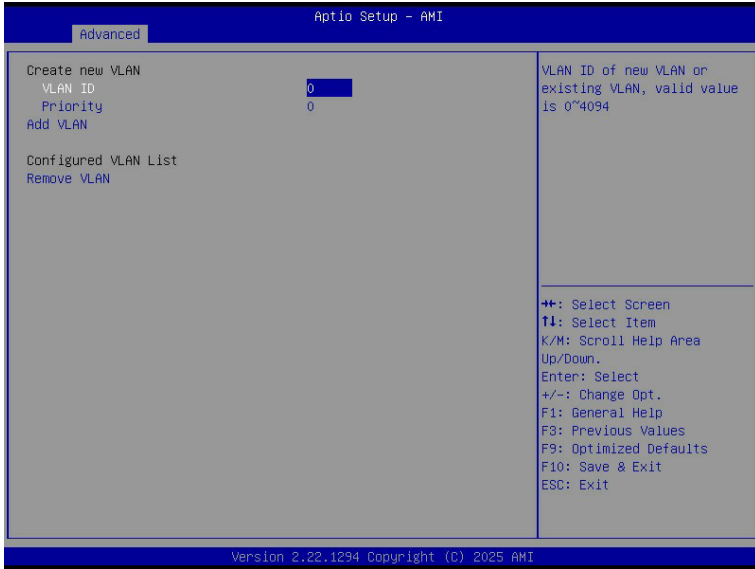

Parameter	Description
Enter Configuration Menu	<p>Press [Enter] to configure advanced items.</p> <ul style="list-style-type: none"> ◆ Create new VLAN ◆ VLAN ID <ul style="list-style-type: none"> – Sets VLAN ID for a new VLAN or an existing VLAN. – Press the <+> / <-> keys to increase or decrease the desired values. – The valid range is from 0 to 4094. ◆ Priority <ul style="list-style-type: none"> – Sets 802.1Q Priority for a new VLAN or an existing VLAN. – Press the <+> / <-> keys to increase or decrease the desired values. – The valid range is from 0 to 7. ◆ Add VLAN <ul style="list-style-type: none"> – Press [Enter] to create a new VLAN or update an existing VLAN. ◆ Configured VLAN List ◆ Remove VLAN <ul style="list-style-type: none"> – Press [Enter] to remove an existing VLAN.

5-2-15 MAC IPv6 Network Configuration

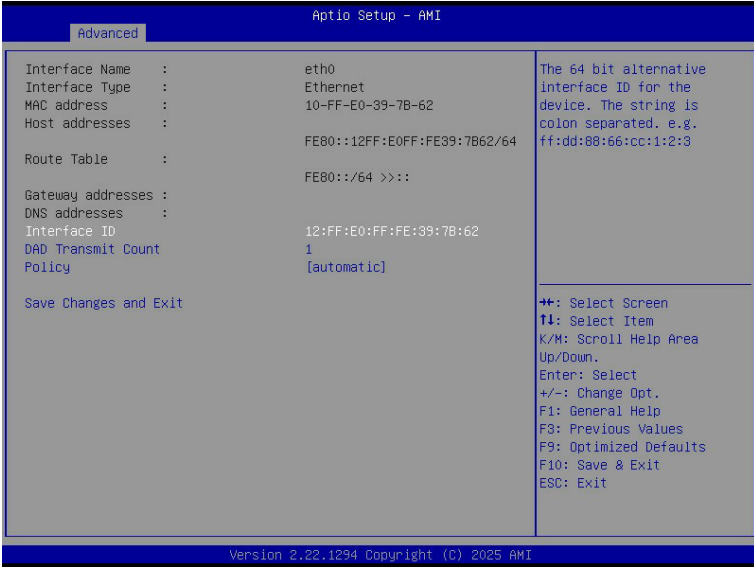

Parameter	Description
Enter Configuration Menu	<p>Press [Enter] to configure advanced items.</p> <ul style="list-style-type: none"> ◆ Displays the MAC Address information. ◆ Interface ID <ul style="list-style-type: none"> – The 64 bit alternative interface ID for the device. The string is colon separated. e.g. ff:dd:88:66:cc:1:2:3. ◆ DAD Transmit Count <ul style="list-style-type: none"> – The number of consecutive Neighbor solicitation messages sent while performing Duplicate Address Detection on a tentative address. A value of zero indicates that Duplicate Address Detection is not performed. ◆ Policy <ul style="list-style-type: none"> – Options available: automatic, manual. ◆ Save Changes and Exit <ul style="list-style-type: none"> – Press [Enter] to save all configurations.

5-2-16 MAC IPv4 Network Configuration

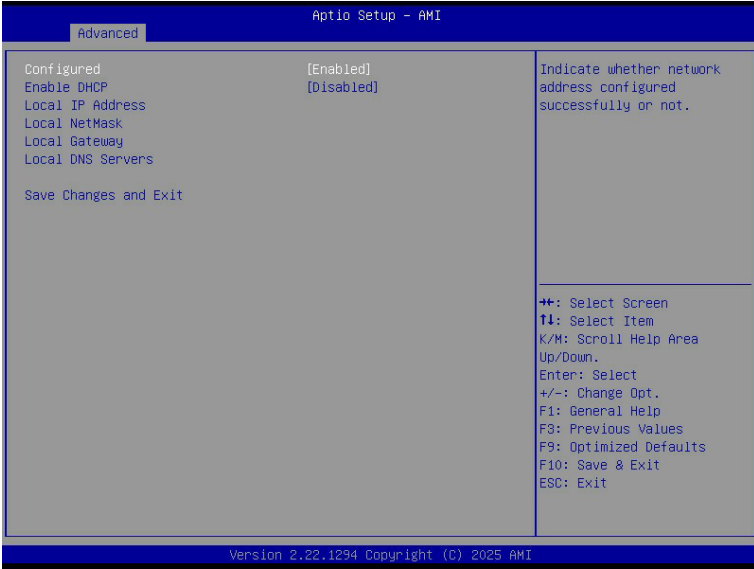

Parameter	Description
Configured	Indicates whether network address is configured successfully or not. Options available: Enabled, Disabled. Default setting is Disabled .
Enable DHCP ^(Note)	Options available: Enabled, Disabled. Default setting is Disabled .
Local IP Address ^(Note)	Press [Enter] to configure local IP address.
Local NetMask ^(Note)	Press [Enter] to configure local NetMask.
Local Gateway ^(Note)	Press [Enter] to configure local Gateway
Local DNS Servers ^(Note)	Press [Enter] to configure local DNS servers
Save Changes and Exit	Press [Enter] to save all configurations.

(Note) This item appears when **Configured** is set to **Enabled**.

5-2-17 Driver Health

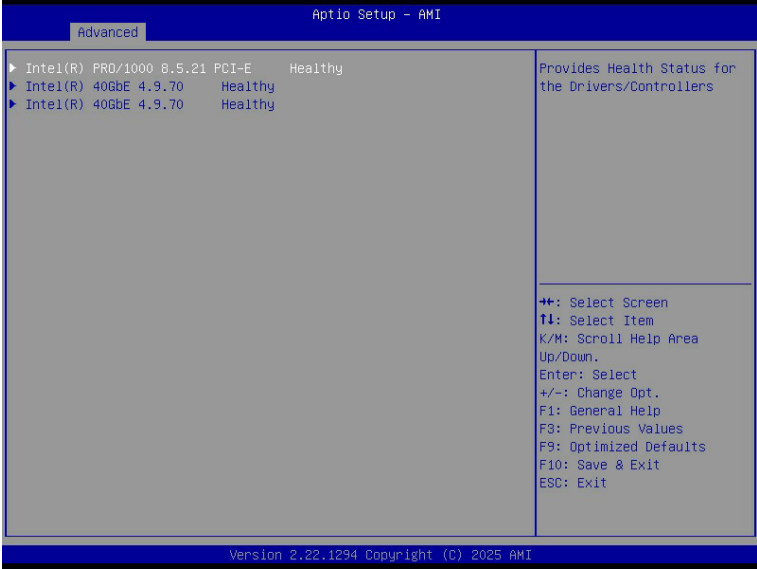

Parameter	Description
Driver Health	Displays driver health status of the devices/controllers if installed.

5-3 Chipset Menu

Chipset Setup menu displays submenu options for configuring the function of Platform Controller Hub(PCH). Select a submenu item, then press <Enter> to access the related submenu screen.

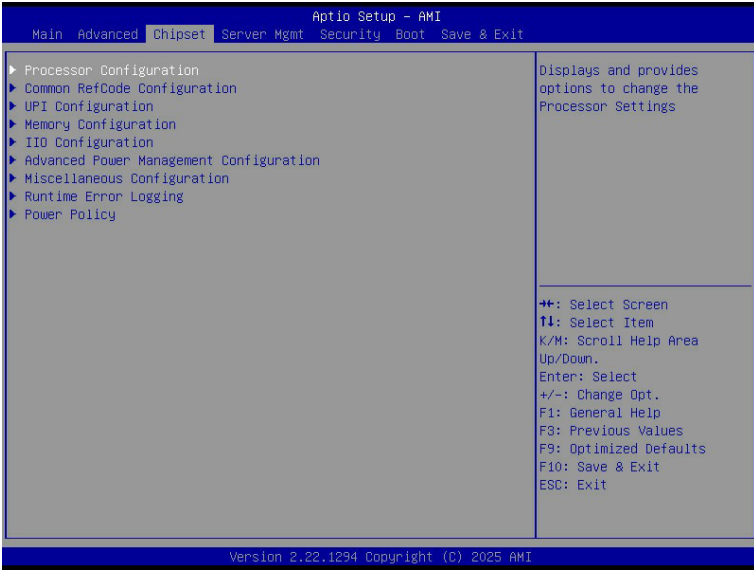

5-3-1 Processor Configuration

Aptio Setup - AMI

Chipset

Processor Configuration		Change Per-Socket Settings

▶ Per-Socket Configuration		
Processor Socket	Socket 0	Socket 1
Processor ID	000A06D1*	000A06D1
Processor Frequency	2.400GHz	2.400GHz
Processor Max Ratio	18H	18H
Processor Min Ratio	08H	08H
Microcode Revision	010003A3	010003A3
L1 Cache RAM(Per Core)	112KB	112KB
L2 Cache RAM(Per Core)	2048KB	2048KB
L3 Cache RAM(Per Package)	491520KB	491520KB
Processor 0 Version	Intel(R) Xeon(R)	6972P
Processor 1 Version	Intel(R) Xeon(R)	6972P
Enable LP [Global]	[ALL LPs]	
Hardware Prefetcher	[Enable]	
Adjacent Cache Prefetch	[Enable]	
DCU Streamer Prefetcher	[Auto]	
DCU IP Prefetcher	[Enable]	
LLC Prefetch	[Disable]	
Homeless Prefetch	[Auto]	
FB Thread Slicing	[Disable]	

		++: Select Screen ↑↓: Select Item K/M: Scroll Help Area Up/Down. Enter: Select +/-: Change Opt. F1: General Help F8: Previous Values F9: Optimized Defaults F10: Save & Exit ESC: Exit
Version 2.22.1294 Copyright (C) 2025 AMI		

Aptio Setup - AMI

Chipset

PRMRR Min Size per domain	16 MiB	
PRMRR Max Size per domain	256 GiB	

Processor Reserved Memory [Outputs]		

PRMRR Size per domain	16 MiB	
PRM Size per socket	16 MiB	
PRM Size per system	16 MiB	

Software Guard Extension (SGX) [Outputs]		

SGX activation state	Deactivated	
SGX error code [HEX]	16	

Software Guard Extension (SGX) [Inputs]		

SGX Factory Reset	[Disabled]	
SW Guard Extensions (SGX)	[Disabled]	
SGX Package Info In-Band Access	[Disabled]	
SGX PRMRR Size Requested	[Auto]	

In Field Scan (IFS)		

▶ In Field Scan (IFS)		

		In Field Scan (IFS) ++: Select Screen ↑↓: Select Item K/M: Scroll Help Area Up/Down. Enter: Select +/-: Change Opt. F1: General Help F8: Previous Values F9: Optimized Defaults F10: Save & Exit ESC: Exit
Version 2.22.1294 Copyright (C) 2025 AMI		

Parameter	Description
Processor Configuration	
Pre-Socket Configuration	<p>Press [Enter] to configure advanced items.</p> <ul style="list-style-type: none"> ◆ Optimize Core Enable <ul style="list-style-type: none"> – Options available: 96 enabled cores per socket [100%], 72 enabled cores per socket [75%], 48 enabled cores per socket [50%], 24 enabled cores per socket [25%]. ◆ CPU Socket 0/1 Configuration <ul style="list-style-type: none"> – Core Disable Bitmap(Hex) <ul style="list-style-type: none"> • Number of Cores to enable. 0 means all cores. FFFFFFFF means to disable all cores. The maximum value depends on the number of CPUs available. Press the numeric keys to adjust desired values.
Processor Socket / Processor ID / Processor Frequency / Processor Max Ratio / Processor Min Ratio / Microcode Revision / L1 Cache RAM(Per Core) / L2 Cache RAM(Per Core) / L3 Cache RAM(Per Package) / Processor # Version	Displays the technical specifications for the installed processor(s).
Enable LP [Global]	Enables Logical processor (Software Method to Enable/Disable Logical Processor threads). Options available: ALL LPs , Single LP.
Hardware Prefetcher	Select whether to enable the speculative prefetch unit of the processor. Options available: Enable , Disable.
Adjacent Cache Prefetch	When enabled, cache lines are fetched in pairs. When disabled, only the required cache line is fetched. Options available: Enable , Disable.
DCU Streamer Prefetcher	Enable/Disable DCU streamer prefetcher. Options available: Enable, Disable, Auto .
DCU IP Prefetcher	Enable/Disable DCU IP Prefetcher. Options available: Enable , Disable.
LLC Prefetch	Enable/Disable LLC Prefetch on all threads. Options available: Disable , Enable.
Homeless Prefetch	Enable/Disable Homeless Prefetch on all threads, Auto will skip the register programming and keep the hardware default setting. Options available: Disable, Enable, Auto .
FB Thread Slicing	Enable/Disable FB (Full Buffer) Thread Slicing per thread. Options available: Disable , Enable.
AMP Prefetch	Options available: Enable , Disable.
Enable Intel(R) TXT	Enable/Disable the Intel Trusted Execution Technology support function. Options available: Enable, Disable .
VMX	Enable/Disable the Vanderpool Technology. This will take effect after rebooting the system. Options available: Disable, Enable .

Parameter	Description
Enable SMX	Enable/Disable Safer Mode Extensions. Options available: Disable , Enable.
AES-NI	Enable/Disable the AES-NI support. Options available: Disable, Enable .
UMONITOR	Options available: Disable , Enable.
Debug Consent	Options available: Disable , Enable.
Memory Encryption (TME)	Options available: Disabled , Enabled.
Total Memory Encryption Multi-Tenant (TME-MT)	Options available: Disabled , Enabled.
Memory Integrity	Options available: Disabled , Enabled.
Trust Domain Extensions (TDX) ^(Note)	Options available: Disabled , Enabled.
Trust Domain Extensions - Connect (TDX Connect)	Options available: Disabled , Enabled.
TDX Secure Arbitration Mode Loader (SEAM Loader)	Options available: Disabled , Enabled.
TME-MT/TDX key split	Designate number of bits for TDX usage. The rest will be used by TME-MT.
SGX error code [HEX]	Displays hexadecimal SGX internal error code.
SGX Factory Reset	Options available: Disabled , Enabled.
SW Guard Extensions (SGX)	Options available: Disabled , Enabled.
SGX Package Info In-Band Access	Options available: Disabled , Enabled.
In-Field Scan (IFS)	<p>Press [Enter] to configure advanced items.</p> <ul style="list-style-type: none"> ◆ Enable SAF^(Note) <ul style="list-style-type: none"> – Options available: Disabled, Enabled. ◆ SAF PRMRR Size Requested <ul style="list-style-type: none"> – Configures SAF size region inside of PRM - just a constituent that may not be equal to the total PRM size.

(Note) Advanced items prompt when this item is defined.

5-3-2 Common RefCode Configuration

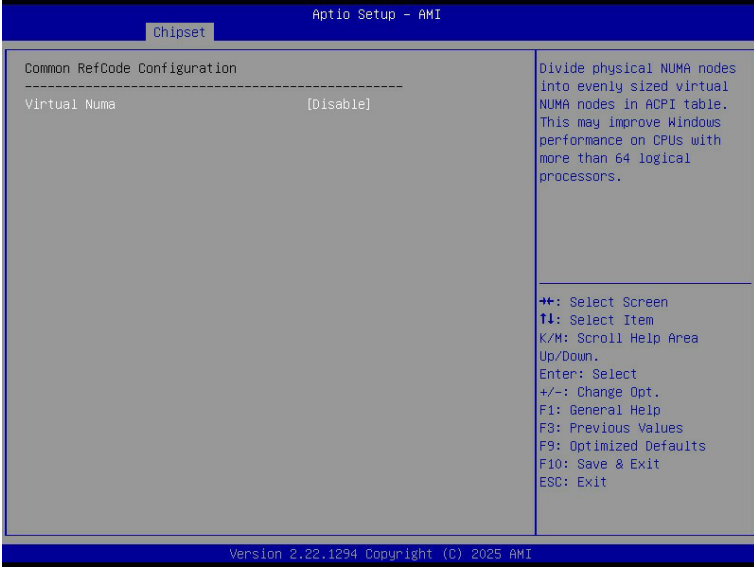

Parameter	Description
Common RefCode Configuration	
Virtual Numa ^(Note)	Divide physical NUMA nodes into evenly sized virtual NUMA nodes in ACPI table. This may improve Windows performance on CPUs with more than 64 logical processors. Options available: Enable, Disable .
Number of Virtual Numa Nodes	The number of virtual NUMA nodes per physical NUMA nodes.

(Note) Advanced items prompt when this item is defined.

5-3-3 UPI Configuration

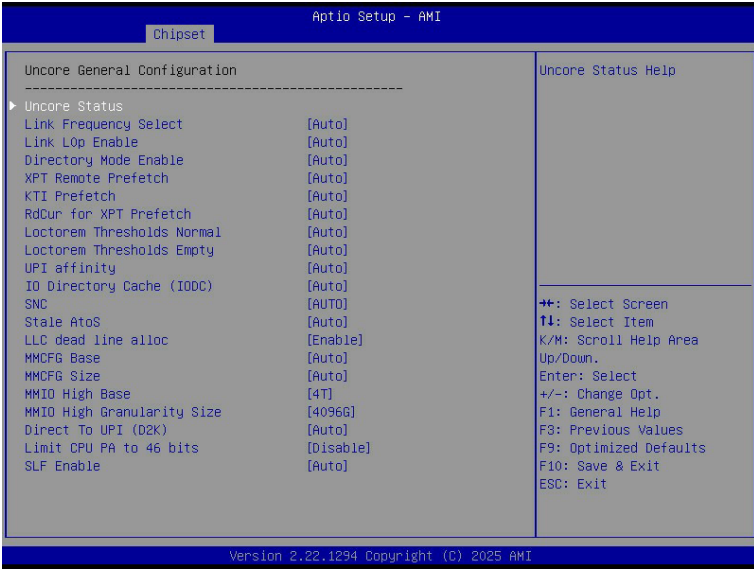

Parameter	Description
UPI General Configuration	Press [Enter] to configure advanced items.
	<ul style="list-style-type: none"> ◆ Uncore Status <ul style="list-style-type: none"> – Press [Enter] to view the Uncore status. ◆ Link Frequency Select <ul style="list-style-type: none"> – Selects the UPI link frequency. – Options available: 16.0GT/s, 20.0GT/s, 24.0GT/s, Auto, Use Per Link Setting. ◆ Link L0p Enable <ul style="list-style-type: none"> – Options available: Disable, Enable, Auto. ◆ Directory Mode Enable <ul style="list-style-type: none"> – Options available: Disable, Enable, Auto. ◆ XPT Remote Prefetch <ul style="list-style-type: none"> – Options available: Disable, Enable, Auto. ◆ XTI Prefetch <ul style="list-style-type: none"> – Options available: Disable, Enable, Auto. ◆ RdCur for XPT Prefetch <ul style="list-style-type: none"> – Options available: Disable, Enable, Auto. ◆ Loctorem Thresholds Normal <ul style="list-style-type: none"> – Options available: Disable, Auto, Low, Medium, High. ◆ Loctorem Thresholds Empty <ul style="list-style-type: none"> – Options available: Disable, Auto, Low, Medium, High.

Parameter	Description
UPI General Configuration (continued)	<ul style="list-style-type: none"> ◆ UPI affinity <ul style="list-style-type: none"> – Options available: Disable, Enable, Auto. ◆ IO Directirt Cache (IODC) <ul style="list-style-type: none"> – Options available: Disable, Auto, Enable for Remote Invltom Hybrid Push, Enable for Remote InltoM AllocFlow, Enable for Remote Invltom Hybrid AllocNonAlloc, Enable for Remote Invltom and Remote WCILF.
	<ul style="list-style-type: none"> ◆ SNC <ul style="list-style-type: none"> – Options available: Disable, Enable, Auto.
	<ul style="list-style-type: none"> ◆ Stale AtoS <ul style="list-style-type: none"> – Enable/Disable Stale A to S directory optimization. – Options available: Disable, Enable, Auto.
	<ul style="list-style-type: none"> ◆ LLC dead line alloc <ul style="list-style-type: none"> – Enable/Disable fill dead lines in LLC. – Options available: Disable, Enable, Auto.
	<ul style="list-style-type: none"> ◆ MMCFG Base <ul style="list-style-type: none"> – Options available: 1G, 1.5G, 1.75G, 2G, 2.25G, 3G, Auto.
	<ul style="list-style-type: none"> ◆ MMCFG Size <ul style="list-style-type: none"> – Options available: 64M, 128M, 256M, 512M, 1G, 2G, Auto.
	<ul style="list-style-type: none"> ◆ MMIO High Base <ul style="list-style-type: none"> – Options available: 248T, 120T, 88T, 60T, 30T, 56T, 40T, 32T, 24T, 16T, 4T, 2T, 1T, 512G, 3584T, Auto.
	<ul style="list-style-type: none"> ◆ MMIO High Granularity Size <ul style="list-style-type: none"> – Selects the allocation size used to assign mmioh resources. – Options available: 1G, 4G, 16G, 32G, 64G, 256G, 1024G, 4096G, Auto.
	<ul style="list-style-type: none"> ◆ Direct To UPI (D2K) <ul style="list-style-type: none"> – Options available: Disable, Enable, Auto.
	<ul style="list-style-type: none"> ◆ Limit CPU PA to 46 bit <ul style="list-style-type: none"> – Options available: Disable, Enable.
	<ul style="list-style-type: none"> ◆ SLF Enable <ul style="list-style-type: none"> – Options available: Disable, Enable, Auto.

5-3-4 Memory Configuration

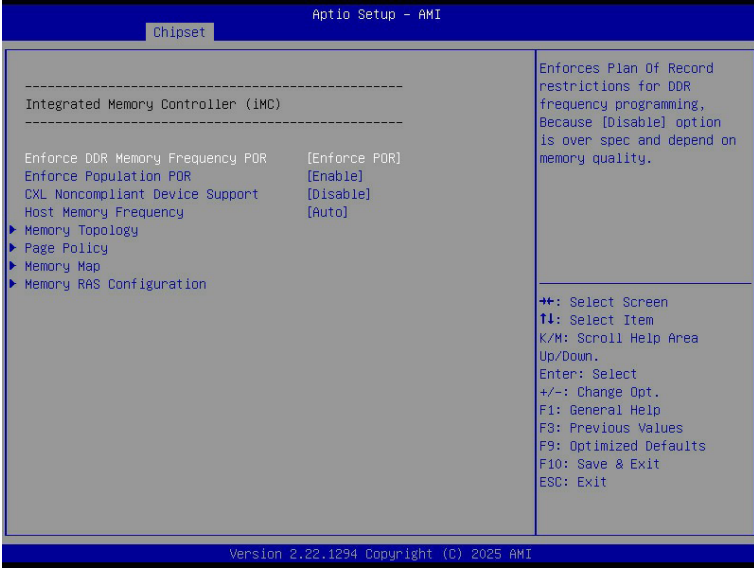

Parameter	Description
Integrated Memory Controller (iMC)	
Enforce DDR Memory Frequency POR	When set to Enable, the system enforces Plan Of Record restrictions for DDR frequency programming. Options available: Enforce POR , Enforce Stretch Goals, Disable.
Enforce Population POR	Options available: Disable, Enable .
CXL Noncompliant Device Support	Options available: Enable, Disable .
Host Memory Frequency	Options available: Auto , 7200, 8000, 8800.
Memory Topology	Press [Enter] to view memory topology with DIMM population information.
Page Policy	Press [Enter] to configure advanced items. <ul style="list-style-type: none"> ◆ Page Policy <ul style="list-style-type: none"> – Selects DRAM page policy. – Options available: Auto, Closed, Adaptive.
Memory Map ^(Note)	Press [Enter] to configure advanced items. <ul style="list-style-type: none"> ◆ Intel(R) Flat Memory Mode Support <ul style="list-style-type: none"> – Options available: Disabled, Enabled. ◆ DDR CXL Heterogeneous Interleave Support <ul style="list-style-type: none"> – Options available: Enabled, Disabled. ◆ In Memory Directory (Dir Backed RSF) with IODC mode <ul style="list-style-type: none"> – Options available: Enabled, Disabled.

(Note) Advanced items prompt when HBM CPU is installed.

Parameter	Description
Memory RAS Configuration	<p data-bbox="391 142 724 166">Press [Enter] to configure advanced items.</p> <ul style="list-style-type: none"> <li data-bbox="391 170 951 310">◆ Mirror Mode <ul style="list-style-type: none"> <li data-bbox="426 200 951 280">– Mirror Mode will set entire 1LM memory in system to be mirrored, consequently reducing the memory capacity by half. Enables the Mirror Mode will disable the XPT Prefetch. <li data-bbox="426 288 815 310">– Options available: Disabled, Full Mirror Mode. <li data-bbox="391 318 951 428">◆ UEFI ARM Mirror <ul style="list-style-type: none"> <li data-bbox="426 348 951 398">– Imitate behavior of UEFI based Address Rang Mirror with setup option. <li data-bbox="426 406 751 428">– Options available: Disabled, Enabled. <li data-bbox="391 435 951 515">◆ Mirror TAD0 <ul style="list-style-type: none"> <li data-bbox="426 465 785 487">– Enable Mirror om entire memory for TAD0. <li data-bbox="426 495 751 515">– Options available: Enabled, Disabled. <li data-bbox="391 523 951 663">◆ Correctable Error Threshold <ul style="list-style-type: none"> <li data-bbox="426 553 951 603">– Correctable Error Threshold (0x01-0x7fff) used for sparing, and leaky bucket. <li data-bbox="426 611 951 663">– Press the <+> / <-> keys to increase or decrease the desired values. <li data-bbox="391 671 951 780">◆ Leaky bucket time window based interface^(Note) <ul style="list-style-type: none"> <li data-bbox="426 700 905 722">– Enable/Disable leaky bucket time window based interface. <li data-bbox="426 730 951 780">– Options available: Disabled, Enabled. Default setting is Disabled. <li data-bbox="391 788 951 928">◆ Leaky bucket time window based interface Hour <ul style="list-style-type: none"> <li data-bbox="426 818 951 868">– Leaky bucket time window based interface hour used for DDR (0-24). <li data-bbox="426 876 951 928">– Press the <+> / <-> keys to increase or decrease the desired values. <li data-bbox="391 936 951 1075">◆ Leaky bucket time window based interface Minute <ul style="list-style-type: none"> <li data-bbox="426 965 951 1016">– Leaky bucket time window based interface minute used for DDR (0-60). <li data-bbox="426 1023 951 1075">– Press the <+> / <-> keys to increase or decrease the desired values. <li data-bbox="391 1083 951 1193">◆ Leaky bucket low bit <ul style="list-style-type: none"> <li data-bbox="426 1113 799 1135">– Configures leaky bucket low bit (0x1 - 0x29). <li data-bbox="426 1143 951 1193">– Press the <+> / <-> keys to increase or decrease the desired values. <li data-bbox="391 1201 951 1310">◆ Leaky bucket high bit <ul style="list-style-type: none"> <li data-bbox="426 1230 806 1252">– Configures leaky bucket high bit (0x1 - 0x29). <li data-bbox="426 1260 951 1310">– Press the <+> / <-> keys to increase or decrease the desired values. <li data-bbox="391 1318 951 1398">◆ ADDDC Sparing^(Note) <ul style="list-style-type: none"> <li data-bbox="426 1348 708 1370">– Enable/Disable ADDDC Sparing. <li data-bbox="426 1378 751 1398">– Options available: Disabled, Enabled.

(Note) Advanced items prompt when this item is defined.

Parameter	Description
Memory RAS Configuration (continued)	<ul style="list-style-type: none"> ◆ Enable ADDDC Error Injection <ul style="list-style-type: none"> – Options available: Disabled, Enabled. ◆ Patrol Scrub <ul style="list-style-type: none"> – Options available: Disabled, Enable at End of POST. ◆ Patrol Scrub Interval <ul style="list-style-type: none"> – Selects the number of hours (1-24) required to complete full scrub. A value of zero means auto. ◆ DDR5 ECS <ul style="list-style-type: none"> – Options available: Disabled, Enabled, Enable ECS with Result Collection.

5-3-5 IIO Configuration

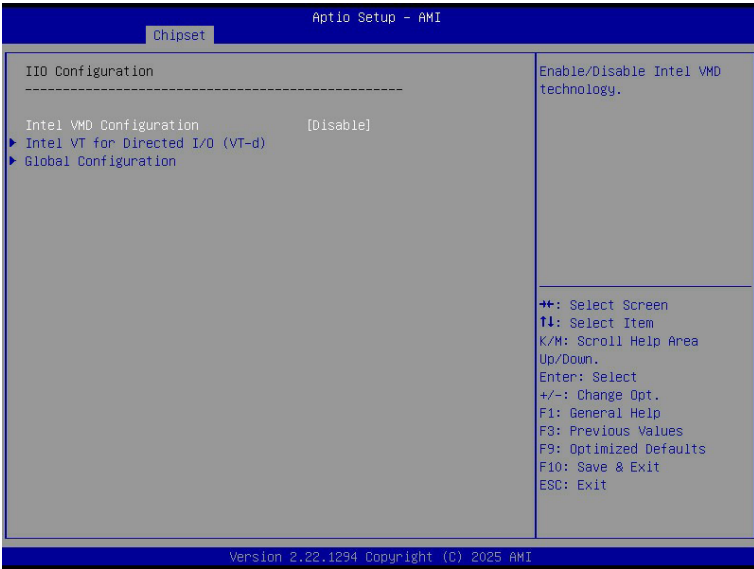

Parameter	Description
IIO Configuration	
Intel® VMD Configuration ^(Note)	Enable/Disable Intel® VMD technology. Options available: Disable , Enable.
Intel® VMD for Non-Hotplug NVMe	Enable/Disable Intel® VMD for Non-Hotplug NVMe. Options available: Disable , Enable.
Intel® VT for Directed I/O (VT-d)	Press [Enter] to configure advanced items. <ul style="list-style-type: none"> ◆ DMA Control Opt-In Flag <ul style="list-style-type: none"> – Enable/Disable DMA_CTRL_PLATFORM_OPT_IN_FLAG in DMAR table in ACPI. Not compatible with Direct Device Assignment (DDA). – Options available: Disable, Enable. ◆ Pre-boot DMA Protection <ul style="list-style-type: none"> – Options available: Disable, Enable. ◆ PCIe ACSCTL ^(Note) <ul style="list-style-type: none"> – Enable/Disable overwrite of PCI Access Control Services Control register in PCI root ports. – Options available: Disable, Enable. ◆ Source Validation <ul style="list-style-type: none"> – Options available: Disabled, Enabled. ◆ Translation Blocking <ul style="list-style-type: none"> – Options available: Disabled, Enabled.

(Note) Advanced items prompt when this item is defined.

Parameter	Description
Intel® VT for Directed I/O (VT-d) (continued)	<ul style="list-style-type: none"> ◆ P2P Request Redirect <ul style="list-style-type: none"> – Options available: Disabled, Enabled. ◆ P2P Completion Redirect <ul style="list-style-type: none"> – Options available: Disabled, Enabled. ◆ Upstream Forwarding Enable <ul style="list-style-type: none"> – Options available: Disabled, Enabled. ◆ Cache Allocation <ul style="list-style-type: none"> – Options available: Enable, Disable. ◆ PRS Capability for PCIe <ul style="list-style-type: none"> – Options available: Disable, Enable, Auto.
Global Configuration	<p>Press [Enter] to configure advanced items.</p> <ul style="list-style-type: none"> ◆ Allocating Write Flows <ul style="list-style-type: none"> – Options available: Non-Allocating, Allocating. ◆ 10-bit Tag Support <ul style="list-style-type: none"> – Options available: Disable, Auto, Force Enable. ◆ Max Read Request Size <ul style="list-style-type: none"> – Options available: Auto, 128B, 256B, 512B, 1024B, 2048B, 4096B. ◆ Relaxed Ordering <ul style="list-style-type: none"> – Options available: Disable, Enable.

5-3-6 Advanced Power Management Configuration

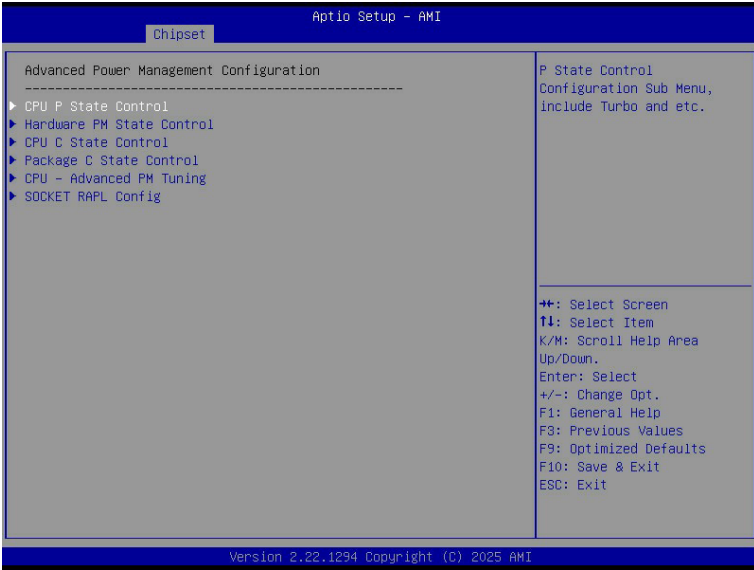

Parameter	Description
CPU P State Control	<p>Press [Enter] to configure advanced items.</p> <ul style="list-style-type: none"> ◆ AVX License Pre-Grant Override <ul style="list-style-type: none"> – Options available: Disable, Enable. ◆ AVX P1 <ul style="list-style-type: none"> – Options available: Nominal, Level 1, Level 2. ◆ SpeedStep (Pstates) <ul style="list-style-type: none"> – Options available: Disable, Enable. ◆ EIST PSD Function <ul style="list-style-type: none"> – Options available: HW_ALL, SW_ALL. ◆ Boot performance mode <ul style="list-style-type: none"> – Options available: Max Performance, Max Efficiency. ◆ Turbo Mode <ul style="list-style-type: none"> – Enable/Disable processor Turbo Mode. – Options available: Disable, Enable. ◆ Energy Efficient Turbo <ul style="list-style-type: none"> – Options available: Disable, Enable. ◆ Perf P-Limit <ul style="list-style-type: none"> – Press [Enter] to configure advanced items. <ul style="list-style-type: none"> » Perf P Limit – Options available: Disable, Enable.

Parameter	Description
Hardware PM State Control	<p>Press [Enter] to configure advanced items.</p> <ul style="list-style-type: none"> ◆ Hardware P-States <ul style="list-style-type: none"> – When this item is disabled, the processor hardware chooses a P-state based on OS Request (Legacy P-States). – In Native mode, the processor hardware chooses a P-state based on OS guidance. – In Out of Band mode, the processor hardware autonomously chooses a P-state (with no OS guidance). – Options available: Disable, Native Mode, Out of Band Mode, Native Mode with No Legacy Support. ◆ HardwarePM Interrupt <ul style="list-style-type: none"> – Options available: Disable, Enable. ◆ Native ASPM <ul style="list-style-type: none"> – Options available: Auto, Enabled, Disabled.
CPU C State Control	<p>Press [Enter] to configure advanced items.</p> <ul style="list-style-type: none"> ◆ Monitor MWAIT <ul style="list-style-type: none"> – Allows Monitor and MWAIT instructions. – Options available: Disable, Enable. ◆ C1 to C1e Promotion <ul style="list-style-type: none"> – CPU will promote C1 request to C1e state. – Options available: Disable, Enable. ◆ ACPI C6x Enumeration <ul style="list-style-type: none"> – Options available: Disable, C6 as ACPI C2, C6 as ACPI C3, C6-P as ACPI C2, C6-P as ACPI C3, Auto. ◆ C6x to C1 Demotion <ul style="list-style-type: none"> – Options available: Disable, Enable. ◆ C1 Undemotion to C6x <ul style="list-style-type: none"> – Options available: Disable, Enable.
Package C State Control	<p>Press [Enter] to configure advanced items.</p> <ul style="list-style-type: none"> ◆ Package C State <ul style="list-style-type: none"> – Configures the state for the C-State package limit. – Options available: C0/C1 state, C2 state, C6(non Retention) state, No Limit, Auto.
CPU - Advanced PM Tuning	<p>Press [Enter] to configure advanced items.</p> <ul style="list-style-type: none"> ◆ Uncore Freq Ratio (COMPUTE/IO) <ul style="list-style-type: none"> – 0: Set dynamic Uncore frequency range from max and min fused values. Otherwise Uncore will run at a constant frequency ratio, the UFS algorithm will be disabled, but physical limits may still reduce frequency. ◆ Uncore Freq Control <ul style="list-style-type: none"> – Options available: Mode 0, Mode 1.

Parameter	Description
CPU - Advanced PM Tuning (continued)	<ul style="list-style-type: none"> ◆ Energy Perf BIAS <ul style="list-style-type: none"> – Press [Enter] to configure advanced items. » Power Performance Tuning <ul style="list-style-type: none"> • Options available: OS Controls EPB, BIOS Controls EPB, PECI Controls EPB. » Energy_PERF_BIAS_CFG mode^(Note) <ul style="list-style-type: none"> • Options available: Performance, Balanced Performance, Balanced Power, Power. ◆ Latency Optimized Mode <ul style="list-style-type: none"> – Options available: Disable, Enabled.
SOCKET RAPL Config	<p>Press [Enter] to configure advanced items.</p> <ul style="list-style-type: none"> ◆ PL1 Power Limit <ul style="list-style-type: none"> – Press the <+> / <-> keys to increase or decrease the desired values. ◆ PL1 Timer Window <ul style="list-style-type: none"> – Options available: 1, 1.25, 1.5, 1.75, 2, 2.5, 3, 3.5, 4, 5. ◆ PL2 Power Limit <ul style="list-style-type: none"> – Press the <+> / <-> keys to increase or decrease the desired values. ◆ PL2 Timer Window <ul style="list-style-type: none"> – Options available: 0.012, 0.014, 0.016, 0.02, 0.023, 0.027, 0.031, 0.039.

(Note) This item is configurable when **Power Performance Tuning** is set to **BIOS Controls EPB**.

5-3-7 Miscellaneous Configuration

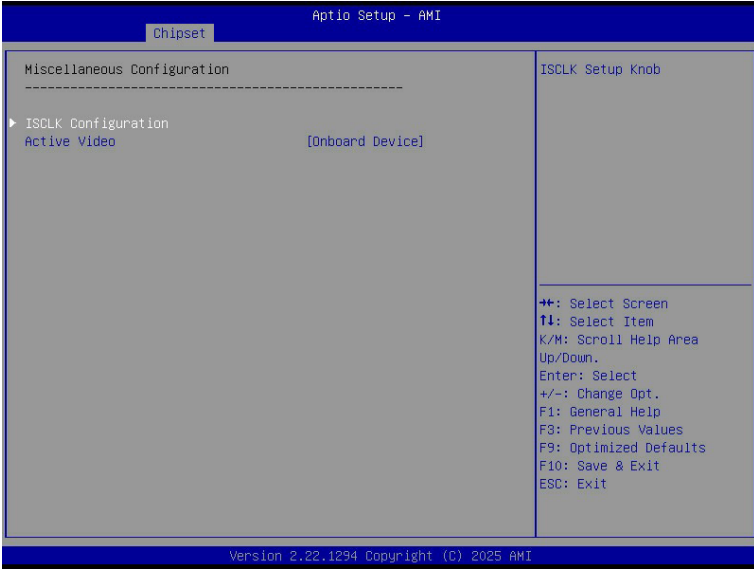

Parameter	Description
Miscellaneous Configuration	
ISCLK Configuration	Press [Enter] to configure advanced items. <ul style="list-style-type: none"> ◆ SSC1/SSC2 Enable <ul style="list-style-type: none"> – Options available: Disable, Enable.
Active Video	Selects the active video type. Options available: Auto, Onboard Device , PCIE Device, Specific PCIE Device.

5-3-8 Runtime Error Logging

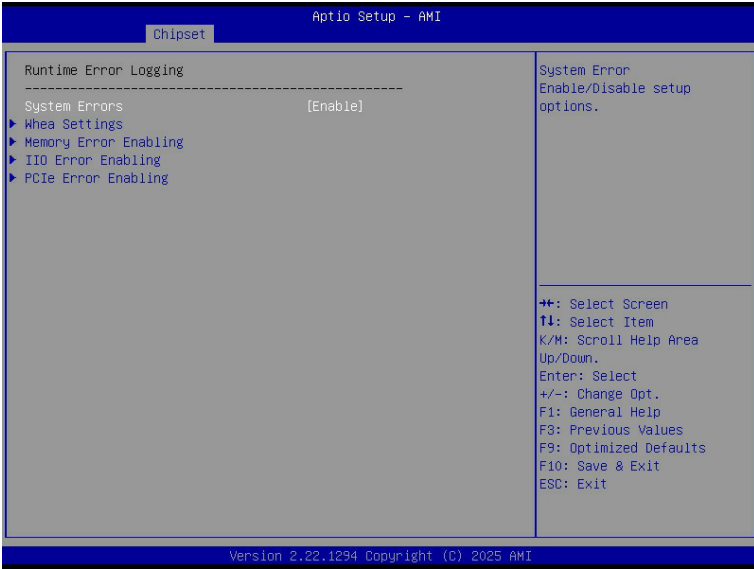

Parameter	Description
Runtime Error Logging	
System Errors	Enable/Disable system error logging function. Options available: Enable , Disable.
Whea Settings	Press [Enter] to configure advanced items. <ul style="list-style-type: none"> ◆ WHEA (Windows Hardware Error Architecture) Support <ul style="list-style-type: none"> - Enable/Disable WHEA Support. - Options available: Enable, Disable.
Memory Error Enabling	Press [Enter] to configure advanced items. <ul style="list-style-type: none"> ◆ Memory Corrected Error <ul style="list-style-type: none"> - Enable/Disable Memory Corrected Error. - Options available: Enable, Disable. ◆ Uncorrected Error disable Memory <ul style="list-style-type: none"> - Enable/Disable the Memory that triggers Uncorrected Error. - Options available: Enable, Disable.
IIO Error Enabling	Press [Enter] to configure advanced items. <ul style="list-style-type: none"> ◆ Os Native AER Support <ul style="list-style-type: none"> - Select FFM or OS native for AER error handling. If select OS native, BIOS also initialize FFM first until handshake, which depends on OS capability. - Options available: Enable, Disable.

Parameter	Description
PCIe Error Enabling	<p data-bbox="309 142 642 166">Press [Enter] to configure advanced items.</p> <ul style="list-style-type: none"> <li data-bbox="309 170 646 252">◆ PCIe Error <ul style="list-style-type: none"> <li data-bbox="344 200 580 224">– Enable/Disable PCIe error. <li data-bbox="344 228 646 252">– Options available: Enable, Disable. <li data-bbox="309 257 923 338">◆ Uncorrected Error^(Note) <ul style="list-style-type: none"> <li data-bbox="344 286 923 310">– Enables and escalates Uncorrectable/Recoverable Errors to error pins. <li data-bbox="344 315 646 338">– Options available: Enable, Disable. <li data-bbox="309 343 749 424">◆ Fatal Error Enable^(Note) <ul style="list-style-type: none"> <li data-bbox="344 373 749 396">– Enables and escalates Fatal Errors to error pins. <li data-bbox="344 401 646 424">– Options available: Enable, Disable. <li data-bbox="309 429 940 545">◆ Assert NMI on SERR^(Note) <ul style="list-style-type: none"> <li data-bbox="344 459 940 514">– Enable/Disable BIOS generates a non-maskable interrupt (NMI) and logs an error when a system error (SERR) occurs. <li data-bbox="344 519 668 542">– Options available: Enabled, Disabled. <li data-bbox="309 550 940 660">◆ Assert NMI on PERR^(Note) <ul style="list-style-type: none"> <li data-bbox="344 580 940 635">– Enable/Disable BIOS generates a non-maskable interrupt (NMI) and logs an error when a processor bus parity error (PERR) occurs. <li data-bbox="344 639 668 663">– Options available: Enabled, Disabled.

(Note) This item appears when **PCIe Error** is set to **Enable**.

5-3-9 Power Policy

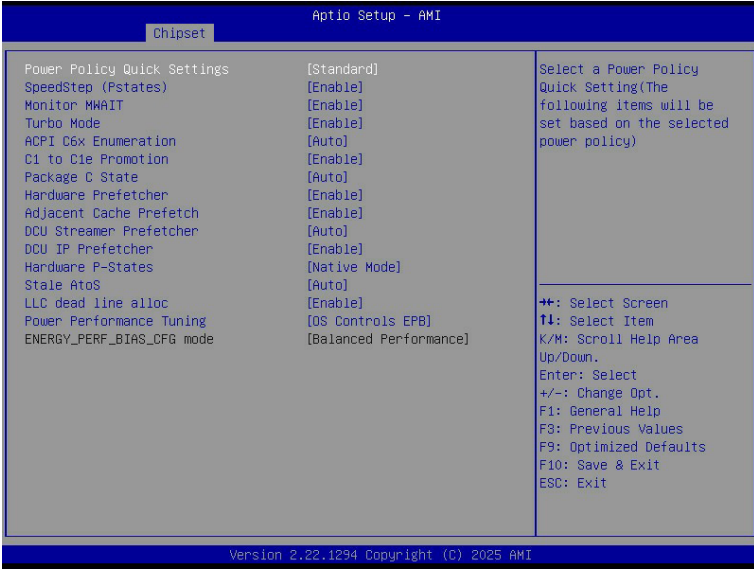

Parameter	Description
Power Policy Quick Settings ^(Note)	Selects a Power Policy Quick Setting. Options available: Standard , Best Performance, Energy Efficient.
SpeedStep (Pstates)	Conventional Intel SpeedStep Technology switches both voltage and frequency in tandem between high and low levels in response to processor load. Options available: Disable, Enable .
Monitor MWAIT	Options available: Disable, Enable .
Turbo Mode	When this item is enabled, the processor will automatically ramp up the clock speed of 1-2 of its processing cores to improve its performance. When this item is disabled, the processor will not overclock any of its core. Options available: Disable, Enable .
ACPI C6x Enumeration	Options available: Disable, C6 as ACPI C2, C6 as ACPI C3, C6-P as ACPI C2, C6-P as ACPI C3, Auto .
C1 to C1e Promotion	Options available: Disable, Enable .
Package C State	Configures the C-State package limit. Options available: C0/C1 state, C2 state, C6(non Retention) state, No Limit, Auto .
Hardware Prefetcher	Options available: Enable , Disable.
Adjacent Cache Prefetch	Options available: Enable , Disable.

(Note) Advanced items prompt when this item is defined.

Parameter	Description
DCU Streamer Prefetcher	Options available: Enable, Disable, Auto .
DCU IP Prefetcher	Options available: Enable , Disable.
Hardware P-States	Options available: Disable, Native Mode , Out of Band Mode, Native Mode with No Legacy Support.
Stale Atos	Options available: Disable, Enable, Auto .
LLC dead line alloc	Options available: Disable, Enable , Auto.
Power Performance Tuning	Options available: OS Controls EPB, BIOS Controls EPB , PECI Controls EPB.
ENERGY_PERF_BIAS_CFG mode	Options available: Performance , Balanced Performance, Balanced Power, Power.
Hyper-Performance	Options available: Disable, Level 1, Level 2, Level 3, Maximum .
Turbo Frequency Lock	Options available: Disable , Enable.

5-4 Server Management Menu

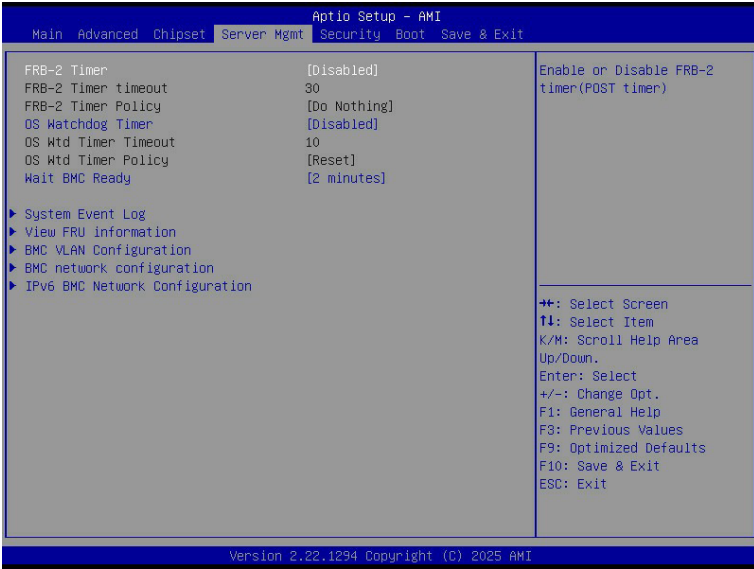

Parameter	Description
FRB-2 Timer	Enable/Disable FRB-2 timer (POST timer). Options available: Enabled, Disabled .
FRB-2 Timer ^(Note1) timeout	Configures the FRB2 Timer timeout. The value is between 1 to 30 minutes. Default setting is 30 .
FRB-2 Timer Policy ^(Note1)	Configures the FRB2 Timer policy. Options available: Do Nothing , Reset, Power Down, Power Cycle.
OS Watchdog Timer	Enable/Disable OS Watchdog Timer function. Options available: Enabled, Disabled .
OS Wtd Timer Timeout ^(Note2)	Configures OS Watchdog Timer. The value is between 1 to 30 minutes. Default setting is 10 .
OS Wtd Timer Policy ^(Note2)	Configure OS Watchdog Timer Policy. Options available: Reset , Do Nothing, Power Down, Power Cycle.
Wait BMC Ready	POST wait BMC ready and reboot system. Options available: Disabled, 2 minutes , 4 minutes, 6 minutes.
System Event Log	Press [Enter] to configure advanced items.
View FRU Information	Press [Enter] to view the FRU information.

(Note1) This item is configurable when **FRB-2 Timer** is set to **Enabled**.

(Note2) This item is configurable when **OS Watchdog Timer** is set to **Enabled**.

Parameter	Description
BMC VLAN Configuration	Press [Enter] to configure advanced items.
BMC network Configuration	Press [Enter] to configure advanced items.
IPv6 BMC Network Configuration	Press [Enter] to configure advanced items.

5-4-1 System Event Log

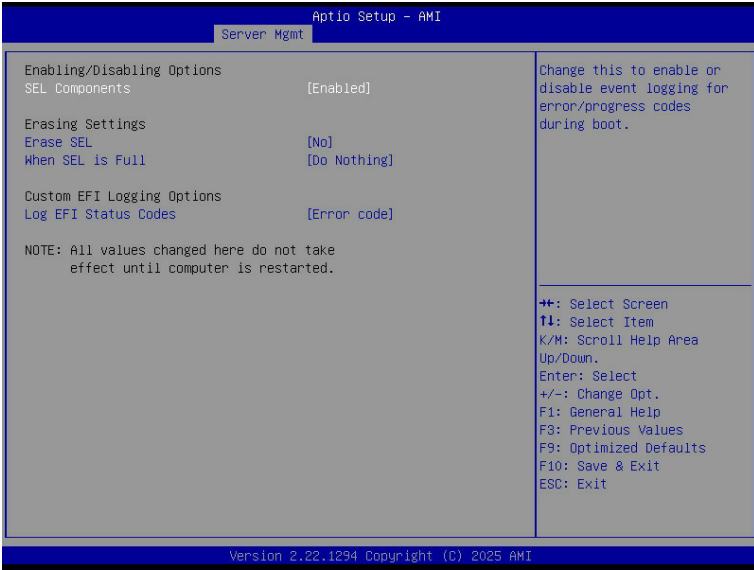

Parameter	Description
Enabling / Disabling Options	
SEL Components	Change this item to enable or disable all features of System Event Logging during boot. Options available: Enabled , Disabled.
Erasing Settings	
Erase SEL	Choose options for erasing SEL. Options available: No , Yes, On next reset, Yes, On every reset.
When SEL is Full	Choose options for reactions to a full SEL. Options available: Do Nothing , Erase Immediately, Delete Oldest Record.
Custom EFI Logging Options	
Log EFI Status Codes	Enable/Disable the logging of EFI Status Codes (if not already converted to legacy). Options available: Disabled, Both, Error code , Progress code.

5-4-2 View FRU Information

The FRU page is a simple display page for basic system ID information, as well as System product information. Items on this window are non-configurable.

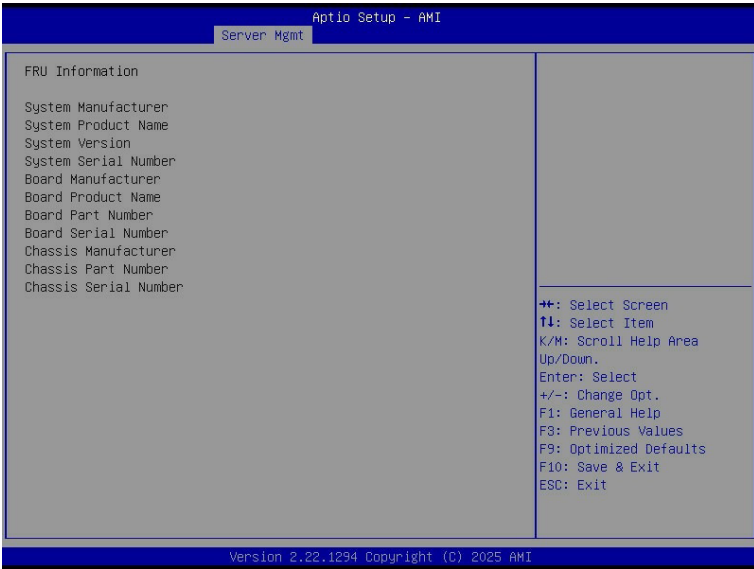

5-4-3 BMC VLAN Configuration

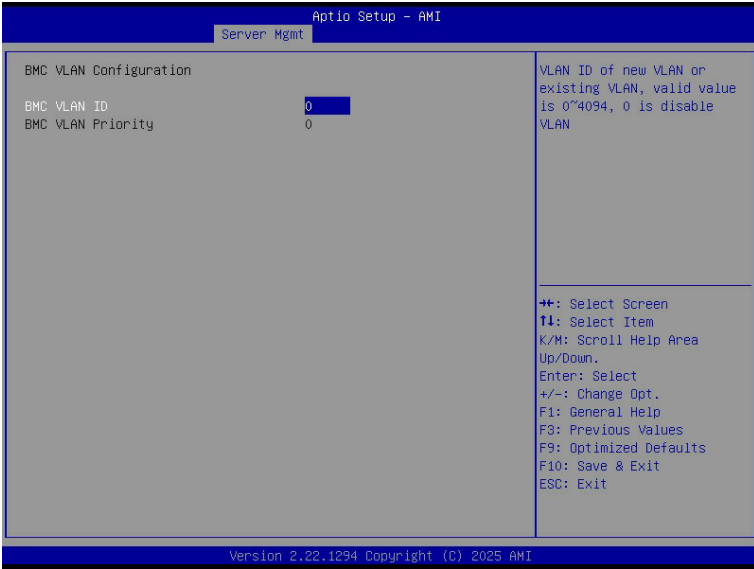

Parameter	Description
BMC VLAN Configuration	
BMC VLAN ID	Select to configure BMC VLAN ID. The valid range is from 0 to 4094. When set to 0, BMC VLAN ID will be disabled.
BMC VLAN Priority	Select to configure BMC VLAN Priority. The valid range is from 0 to 7. When BMC VLAN ID is set to 0, BMC VLAN Priority will not be selected.

5-4-4 BMC Network Configuration



Parameter	Description
BMC network configuration	
Select NCSI and Dedicated LAN	Options available: Do Nothing, Model1(Dedicated), Model2(NCSI), Mode3(Failover) .
Lan Channel 1	
Configuration Address source	Selects to configure LAN channel parameters statically or dynamically (DHCP). Options available: Unspecified, Static, DynamicBmcDhcp .
Station IP address	Displays IP Address information.
Subnet mask	Displays Subnet Mask information. Please note that the IP address must be in three digitals, for example, 192.168.000.001.
Router IP address	Displays the Router IP Address information.
Station MAC address	Displays the MAC Address information.
Real-time get BMC network address	Press [Enter] will set LAN mode and Address source and then get IP, Subnet, Gateway and MAC address.

5-4-5 IPv6 BMC Network Configuration

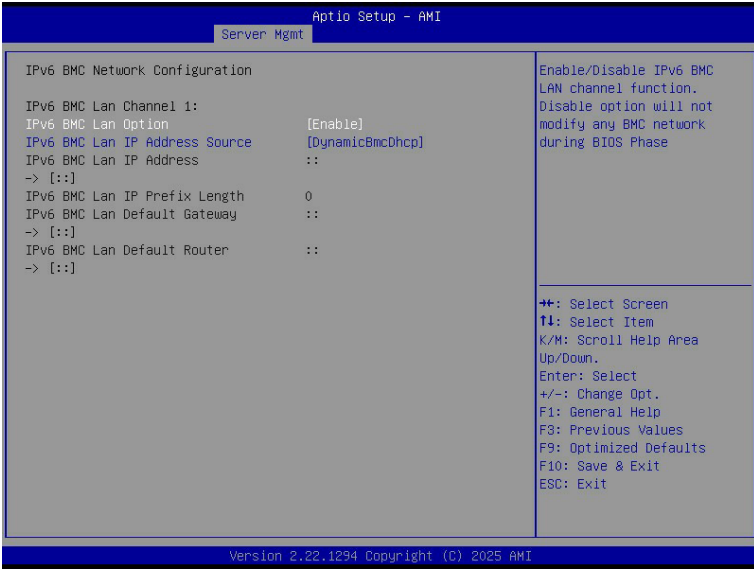

Parameter	Description
IPv6 BMC network configuration	
IPv6 BMC Lan Channel 1	
IPv6 BMC Lan Option	Enable/Disable IPv6 BMC LAN channel function. When this item is disabled, the system will not modify any BMC network during BIOS phase. Options available: Unspecified, Disable, Enable .
IPv6 BMC Lan IP Address Source	Selects to configure LAN channel parameters statically or dynamically (by BIOS or BMC). Options available: Unspecified, Static, DynamicBmcDhcp .
IPv6 BMC Lan IP Address/Prefix Length	Check if the IPv6 BMC LAN IP address matches those displayed on the screen.

5-5 Security Menu

The Security menu allows you to safeguard and protect the system from unauthorized use by setting up access passwords.



There are two types of passwords that you can set:

- **Administrator Password**
Entering this password will allow the user to access and change all settings in the Setup Utility.
- **User Password**
Entering this password will restrict a user's access to the Setup menus. To enable or disable this field, a Administrator Password must first be set. A user can only access and modify the System Time, System Date, and Set User Password fields.

Parameter	Description
Administrator Password	Press [Enter] to configure the administrator password.
User Password	Press [Enter] to configure the user password.
Secure Boot	Press [Enter] to configure advanced items.
Secure Flash Update	Press [Enter] to view information of secure Flash update support.

5-5-1 Secure Boot

The Secure Boot feature is applicable if supported by your Operating System.

If your Operating System is not supporting Secure Boot, the system will hang when starting the Operating System.

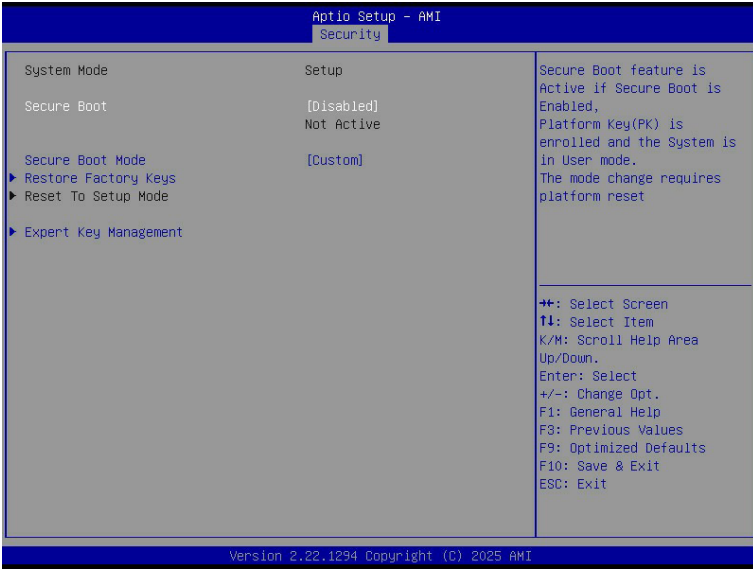

Parameter	Description
System Mode	Displays if the system is in User mode or Setup mode.
Secure Boot	Enable/ Disable the Secure Boot function. Options available: Enabled, Disabled .
Secure Boot Mode ^(Note)	Secure Boot requires all the applications that are running during the booting process to be pre-signed with valid digital certificates. This way, the system knows all files being loaded before the Operating System loads to the login screen have not been tampered with. When set to Standard, it will automatically load the Secure Boot keys from the BIOS databases. When set to Custom, you can customize the Secure Boot settings and manually load its keys from the BIOS database. Options available: Standard , Custom.
Restore Factory Keys	Forces the system to user mode and installs factory default Secure Boot key database.
Reset To Setup Mode	Reset the system to Setup Mode.

(Note) Advanced items prompt when this item is set to **Custom**.

Parameter	Description
Expert Key Management	<p data-bbox="333 158 668 181">Press [Enter] to configure advanced items.</p> <p data-bbox="333 185 939 236">Please note that this item is configurable when Secure Boot Mode is set to Custom.</p> <ul style="list-style-type: none"> <li data-bbox="333 239 951 351">◆ Factory Key Provision <ul style="list-style-type: none"> <li data-bbox="370 268 951 319">– Allows to provision factory default Secure Boot keys when system is in Setup Mode. <li data-bbox="370 323 692 351">– Options available: Enabled, Disabled. <li data-bbox="333 354 951 432">◆ Restore Factory Keys <ul style="list-style-type: none"> <li data-bbox="370 382 926 406">– Installs all factory default keys. It will force the system in User Mode. <li data-bbox="370 409 607 432">– Options available: Yes, No. <li data-bbox="333 435 951 514">◆ Reset To Setup Mode <ul style="list-style-type: none"> <li data-bbox="370 464 657 487">– Reset the system to Setup Mode. <li data-bbox="370 490 607 514">– Options available: Yes, No. <li data-bbox="333 517 951 595">◆ Enroll Efi Image <ul style="list-style-type: none"> <li data-bbox="370 545 902 597">– Press [Enter] to enroll SHA256 hash of the binary into Authorized Signature Database (db). <li data-bbox="333 598 951 677">◆ Export Secure Boot variables <ul style="list-style-type: none"> <li data-bbox="370 627 939 678">– Copy NVRAM content of Secure Boot variables to files in a root folder on a file system device. <li data-bbox="333 680 951 743">◆ Secure Boot variable <ul style="list-style-type: none"> <li data-bbox="370 708 896 743">– Displays the current status of the variables used for secure boot. <li data-bbox="333 746 951 856">◆ Platform Key (PK) <ul style="list-style-type: none"> <li data-bbox="370 774 804 798">– Displays the current status of the Platform Key (PK). <li data-bbox="370 801 678 824">– Press [Enter] to configure a new PK. <li data-bbox="370 827 602 856">– Options available: Update. <li data-bbox="333 859 951 992">◆ Key Exchange Keys (KEK) <ul style="list-style-type: none"> <li data-bbox="370 887 944 911">– Displays the current status of the Key Exchange Key Database (KEK). <li data-bbox="370 914 905 965">– Press [Enter] to configure a new KEK or load additional KEK from storage devices. <li data-bbox="370 969 671 992">– Options available: Update, Append. <li data-bbox="333 995 951 1128">◆ Authorized Signatures (DB) <ul style="list-style-type: none"> <li data-bbox="370 1023 905 1047">– Displays the current status of the Authorized Signature Database. <li data-bbox="370 1050 944 1102">– Press [Enter] to configure a new DB or load additional DB from storage devices. <li data-bbox="370 1105 671 1128">– Options available: Update, Append. <li data-bbox="333 1132 951 1273">◆ Forbidden Signatures (DBX) <ul style="list-style-type: none"> <li data-bbox="370 1160 902 1183">– Displays the current status of the Forbidden Signature Database. <li data-bbox="370 1186 891 1238">– Press [Enter] to configure a new dbx or load additional dbx from storage devices. <li data-bbox="370 1241 671 1273">– Options available: Update, Append.

Parameter	Description
Key Management (continued)	<ul style="list-style-type: none"> ◆ Authorized TimeStamps (DBT) <ul style="list-style-type: none"> – Displays the current status of the Authorized TimeStamps Database. – Press [Enter] to configure a new DBT or load additional DBT from storage devices. – Options available: Update, Append. ◆ OsRecovery Signatures <ul style="list-style-type: none"> – Displays the current status of the OsRecovery Signature Database. – Press [Enter] to configure a new OsRecovery Signature or load additional OsRecovery Signature from storage devices. – Options available: Update, Append.

5-6 Boot Menu

The Boot menu allows you to set the drive priority during system boot-up. BIOS setup will display an error message if the legacy drive(s) specified is not bootable.

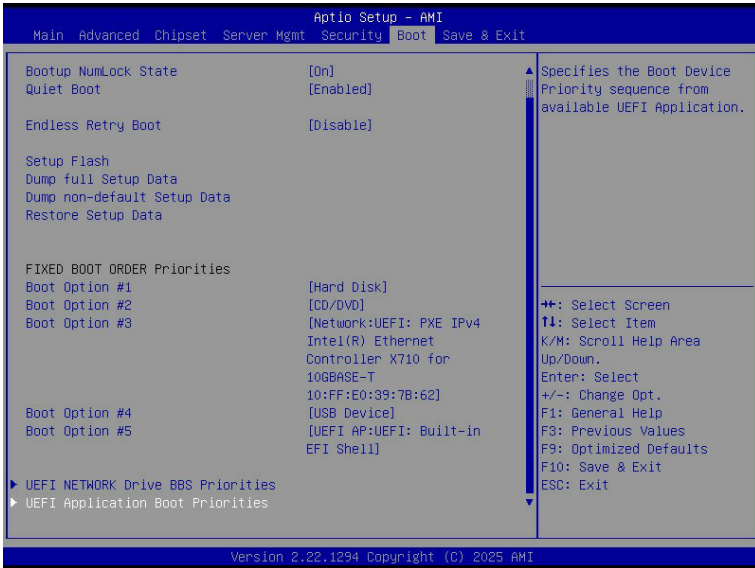
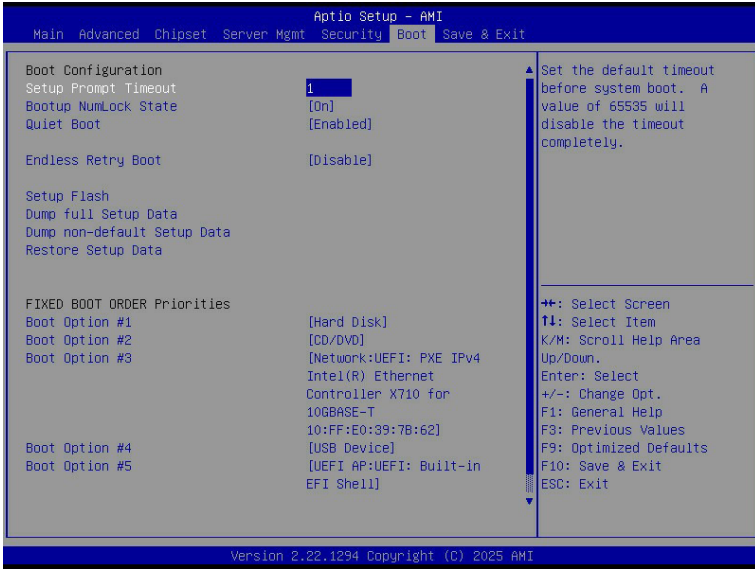

Parameter	Description
Boot Configuration	
Setup Prompt Timeout	Number of seconds to wait for setup activation key. 65535 (0xFFFF) means indefinite waiting. Press the numeric keys to input the desired values.
Bootup NumLock State	Enable/Disable the Bootup NumLock function. Options available: On , Off.
Quiet Boot	Enable/Disable showing the logo during POST. Options available: Enabled , Disabled.
Endless Retry Boot	Options available: Disable , Enable.
Setup Flash	Press [Enter] to run setup flash.
Dump full Setup Data	Press [Enter] to dump full setup data to file.
Dump non-default Setup Data	Press [Enter] to dump non-default setup data to file.
Restore Setup Data	Press [Enter] to restore setup data from file.
FIXED BOOT ORDER	
Priorities	
Boot Option #1 / #2 / #3 / #4 / #5	Press [Enter] to configure the boot order priority. By default, the server searches for boot devices in the following sequence: <ol style="list-style-type: none"> 1. Hard drive. 2. CD-COM/DVD drive. 3. USB device. 4. Network. 5. UEFI.
UEFI Network Drive BBS Priorities	Press [Enter] to configure the boot priority.
UEFI Application Boot Priorities	Press [Enter] to configure the boot priority.

5-7 Save & Exit Menu

The Save & Exit menu displays the various options to quit from the BIOS setup. Highlight any of the exit options then press <Enter>.

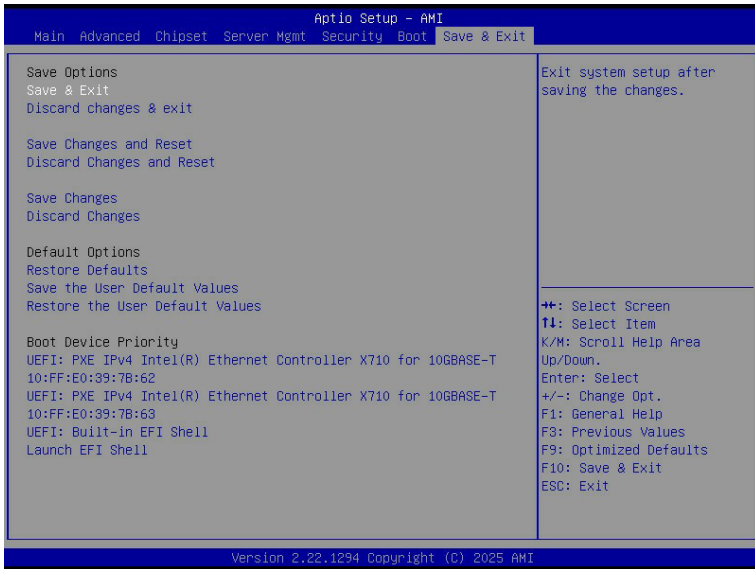

Parameter	Description
Save Options	
Save and Exit	Saves changes made and closes the BIOS setup. Options available: Yes, No.
Discard changes and exit	Discards changes made and exits the BIOS setup. Options available: Yes, No.
Save Changes and Reset	Restarts the system after saving the changes made. Options available: Yes, No.
Discard Changes and Reset	Restarts the system without saving any changes. Options available: Yes, No.
Save Changes	Saves changes done so far to any of the setup options. Options available: Yes, No.
Discard Changes	Discards changes made and closes the BIOS setup. Options available: Yes, No.
Default Options	

Parameter	Description
Restore Defaults	Loads the default settings for all BIOS setup parameters. Setup Defaults are quite demanding in terms of resources consumption. If you are using low-speed memory chips or other kinds of low-performance components and you choose to load these settings, the system might not function properly. Options available: Yes, No.
Save the User Default Values	Saves the changes made as the user default settings. Options available: Yes, No.
Restore the User Default Values	Loads the user default settings for all BIOS setup parameters. Options available: Yes, No.
Boot Device Priority	Press [Enter] to configure the device as the boot-up drive.
Launch EFI Shell	Attempts to Launch EFI Shell application (Shell.efi) from one of the available file system devices.

5-8 BIOS Recovery

The system has an embedded recovery technique. In the event that the BIOS becomes corrupt the boot block can be used to restore the BIOS to a working state. To restore your BIOS, please follow the instructions listed below:

Recovery Instruction:

1. Copy the XXX.rom to USB drive.
2. Setting BIOS Recovery jump to enabled status.
3. Boot into BIOS recovery.
4. Run Proceed with flash update.
5. BIOS updated.

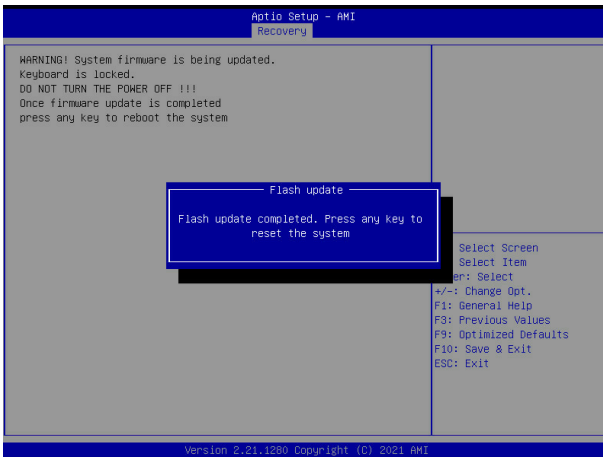



Designed by

**GIGA
COMPUTING**